

NOTICE TO ALL ATTENDEES

Before using any or all of these sample forms and checklists provided in this course of instruction, you're staff attorney or state prosecutor should review these forms and checklists to insure that they comply with all respective state case law, state statutory law as well as agency or company policy and procedure.

Permission to use, change and or reproduce these forms and checklists is hereby granted to each attendee to assist him/her or their agency or company in their investigations.

These forms have been designed to be included at no charge in the vehicle fire class. Use of these forms and or reproduction is permissible as long as they are not sold for profit. Tim Yandell, Steve Riggs and Public Agency Training Council®

The use of the 921 forms should only be used with credit being given to NFPA® and NFPA® 921-2011 edition.

NFPA® 921 VEHICLE INSPECTION FIELD NOTES courtesy of National Fire Protection Association.

**1 Batterymarch Park,
Quincy, Massachusetts_02169-7471
Tel: +1 617 770-3000
Sales/Member Services
+1 800 344-3555**

Copyright © 2011 Public Agency Training Council®

Tim Yandell & Steve Riggs

WEATHER CONDITIONS

CASE OR FILE # _____ DATE: _____

Location or GPS Coordinates: _____

Conditions at time of reported fire or approximate time:

CLEAR RAIN STORMS FOG SNOW ICE SLEET

SEVER WEATHER OTHER: _____

TIME: _____

TEMPERATURE: _____

WIND SPEED: _____ MPH

WIND DIRECTION: _____ (FROM)

WIND CHILL _____ DEGREES
(IF BELOW 32 DEGRES)

HEAT INDEX _____ DEGREES
(IF ABOVE 95 DEGREES)

HUMIDITY: _____ %

DEWPOINT: _____ %

BAROMETER: _____ IN.

<http://www.wunderground.com>

NFPA 921-2011 Edition Weather Conditions 14.2.3, 17.3.3.5, 18.3.5(Weather data),
20.2.2.1(12), 21.14.2.2.1, 26.3, 26.3.1 (Weather history),
28.9.3.6.2(3) (Water & Weather Conditions).

VEHICLE FIRE INVESTIGATION

CASE OR File # _____ DATE: _____ TIME: _____

REPORTING PARTY _____
(Name) Address (Phone #)

OCCUPANT _____ PHONE# _____
(Last) (First) (Middle)

OWNER _____ PHONE# _____
(Last) (First) (Middle)

OWNER ADDRESS _____

PERSON DISCOVERING THE FIRE _____
(Last) (First) (Middle)

ADDRESS _____ PHONE # _____

COLOR OF SMOKE _____ AMOUNT OF SMOKE _____

WERE THERE ANY ODORS _____

WAS THE VEHICLE IN A BUILDING [] YES [] NO IF YES WHAT TYPE OF BUILDING ?

(Garage, Repair Shop, Carport, etc.)

TYPE OF CONSTRUCTION _____
(Wood, Metal, Cement Etc.)

IF IN A BUILDING, WAS IT OCCUPIED AT THE TIME OF THE FIRE [] YES [] NO

IF YES NUMBER OF OCCUPANTS _____ LOSS TO THE BUILDING \$ _____

LOSS TO CONTENTS \$ _____ CASUALTIES _____
Exterior examination [] Burn Site [] Other Area

If other area where? _____
(List address or location where examination is conducted)

1. Check surrounding area if at burn site for:

A. Containers or caps _____

B. Possible trailers _____

C. Tire impressions or signs of other vehicles _____

D. Any signs of towing [] yes [] no if yes explain: _____

E. Is the vehicle in a secluded or hidden area _____

2. The exterior of the vehicle:

A. Windshield in tact? yes no damaged _____

B. Any glass on the exterior? yes no If yes explain: _____

C. Any forced entry yes no undetermined

D. Broken head or tail lights yes no undetermined if yes explain:

E. Hood up down other _____

Note* Even if the hood is burned away note the hinge positions: up down

other _____

F. Are there any radial patterns on the hood or other area yes No If yes explain:

G. Are there hub caps on all wheels yes no undetermined

H. Any fire under the vehicle? yes no if yes explain _____

I. Is the gas cap on the filler tube? yes no other _____

3. Engine compartment, motor and parts under the hood:

A. Any signs fire originated under hood? [] yes [] no [] undetermined

B. Any fire patterns on interior of hood? [] yes [] no [] undetermined

C. Any signs of fire on top of the motor? [] yes [] no [] undetermined

If yes to above explain: _____

D. This vehicle is equipped with: [] Fuel Injection [] Carburetor [] Nitrous Oxide

E. This vehicle operates on: [] Gasoline [] Diesel [] Compressed Natural Gas

[] Propane [] Fuel Cell Technology [] Hybrid [] Other If other explain:

F. Visually inspect carburetor, injection system, fuel rails, injectors, regulator, or

technology that applies to this vehicle for signs of failure or tampering _____

G. Are there visible signs of failure in carburetor, fuel rails, injection system or technology that applies [] yes [] no [] undetermined If yes explain: _____

H. Is the air cleaner present [] yes [] no [] undetermined

I. Condition of fuel pump if visible _____

J. Does it appear there is any fuel in the system

[] yes [] no [] undetermined if further explain _____

K. Examine all fuel lines for integrity, malfunctions or obvious failures _____

L. Are fuel line ends in tact and connected [] yes [] no [] undetermined

If no explain: _____

4. Electrical system

- A. Is there a battery in the car yes no undetermined
- B. Is there acid and water in the battery yes no unknown Maintenance Free
- C. Are the battery caps in place? yes no unknown Maintenance Free
- D. Is there fire damage to the battery yes no
if yes where _____
- E. Are the cables connected to the (battery & starter) yes no
- F. If not who disconnected _____ unknown
- G. Any evidence of arcing yes no unknown if yes explain _____

- H. Examine distributor cap, electronic ignition, spark plug wires and coil in tact or present? yes no unknown
- I. Are all spark or glow plugs present yes no unknown
- J. What is the condition of the spark/glow plugs _____
- K. Did you remove the plugs and inspect? Yes No if yes describe findings :____

- L. Were plug wires connected or disconnected yes no unknown
- M. Examine wiring harness: Did there appear to be damage from an external heat source or any internal heating, arcing or shorting: _____

- N. Did wiring harness seem to be in tact and appear normal?[yes no unknown
If no explain:_____
- O. Condition of the alternator or generator present missing damaged
- P. Bearing condition of alternator if you can determined?_____
- Q. Voltage regulator condition if external present damaged Internal
- R. Condition of main power plug feeding alternator present damaged unknown
- S. Documentation of fuses, breakers and load center using fuse/load center form?
 yes no if no explain:_____

5. General inspection:

A. Is the radiator damaged yes no [] undetermined if yes explain: _____

B. Has the core melted yes no undetermined

C. Any evidence of cracked block or heads? yes no undetermined If yes explain _____

G. Is the drive shaft present and connected? yes no n/a

H. If transaxle type vehicle: is transaxle present and the constant velocity joints connected? yes no n/a unknown _____

6. Passenger compartment:

A. Was forcible entry required yes no if yes explain _____

B. Windshield glass damage more at: top bottom undetermined

C. Condition of upholstery _____

D. Tensile strength of springs _____

E. Were there any floor mats _____

F. Any evidence of fire under seats yes no undetermined If yes explain _____

J. Seat material vinyl cloth leather undetermined other _____

K. Any missing items (radio, CD, tape player, cell phone, On-star GPS etc.

L. What position is the transmission in park neutral reverse gear undetermined other _____

M. Position of ignition switch? run off accessory undetermined

N. Is there a key or keys in the ignition yes no unknown if yes how many keys _____

O. Has steering column been defeated [] yes [] no [] unknown if yes explain:

P. What type of debris is in the floorboard area _____

Q. Is the windshield glass in the floor board? [] yes [] no [] other _____

R. Is side window glass in the floor board? [] yes [] no [] other _____

S. Is there any debris underneath the glass in the floor board? [] yes [] no

if yes explain: _____

T. Any samples taken from the interior of the vehicle [] yes [] no

if yes where and what was taken? _____

7. Cargo areas

A. Is there a spare tire [] yes [] no [] unknown

B. If yes, what is it's condition _____

C. Is there a jack and tire tool [] yes [] no [] unknown

D. Is the spare designed for this vehicle [] yes [] no [] unknown

E. Is the gas cap on the gas tank filler tube [] yes [] no [] unknown

F. If no was it found [] yes [] no if yes where? _____

G. What is the condition of the filler hose or tube? _____

H. Any signs of tampering or tool marks on the vehicle [] yes [] no

if yes explain _____

8. Lift vehicle

A. Trace all fuel lines from the tank to motor _____

B. Check all of the clamps and fittings _____

C. Any signs of tampering _____

D. Check exhaust system and muffler _____

E. Is there any fuel in the tank yes no unknown

F. If yes how much approximately 1/4 1/2 3/4 full unknown

G. Is there a fuel filter yes no unknown

H. If yes was it properly attached yes no unknown if no: explain _____

I. Are the connections tight yes no unknown

J. Was the fuel filter and connections proper for the system in use? Example:
high pressure/low pressure yes no

9. List all evidence or parts removed from the vehicle and the disposition thereof

Laboratory Results: negative positive pending/unknown other

Please explain if necessary below:

Final determination:

Accidental Undetermined/Under Investigation Incendiary

INTERIOR MATERIAL DEGRADATION/TEMPERATURES AND FMVSS 302 BURN RATES

Part	Type	Plastic	Degradation Temperature	FMVSS 302 Burn Rate*
Seat Covers	Woven cloth	Nylon/polyester	420-480	SE-2.3"
	Knitted cloth	Nylon	480	SE
	Simulated leather	Vinyl	300	SE
Seat Cushions	Foam	Polyurethane	400-500	SE-1.5"
Seat Backs	Cover panels	Polypropylene	335	0.5-2.5"
Seat Belt Webbing	All	Nylon/polyester	420-480	SE
Door Trim	Panels	Polypropylene	335	0.5-2.5"
Kick Panels	-----	Polypropylene	335	0.5-2.5"
Dash Pad	Skin/foam	Vinyl-urethane	300-400	SE-1.0"
Instrument Panel	-----	ABS	250	1.5-3.0"
Instrument Cluster	Lens	Acrylic	300	0.6-1.4"
Ash Tray	-----	Phenolic	500	SE
Carpet	Tufted	Nylon	420-480	SE-1.0"
Amberlite	Thermal barrier	Cotton waste	450	SE
Mastic	Sound deadner	Asphalt (filled)	500	SE
Trim Parts	-----	Acetal	350	1.5-2.5"
Glove Box	Inner panel	Polyethylene	220	1.5-3.0"
Wire Coating	Insulation	Vinyl	300-325	SE
Harness Conduit	Insulation	Nylon	425	SE
Heater Ducts	-----	Polypropylene	335	0.5-2.5"

se= self extinguishing (numbers are in inches/minute)

Information Courtesy NFPA® 921

Table 25.3.1 Properties of Ignitable Liquids

Liquid	Flash Point ^a		Autoignition Temperature ^b		Flammability Limits ^c		Boiling Point ^d				Density ^e Vapor (Air = 1)
					LFL	UFL	IBP		FPB		
	°C	°F	°C	°F	%	%	°C	°F	°C	°F	
Gasoline	-45 to -40	-49 to -40	257-280	495-536	1.4	7.6	26-49	78-120	171-233	339-452	3-4
Diesel fuel (fuel oil #2)	38-62	100-145	254-260	489-500	0.4	7	127-232	260-450	357-404	675-760	5-6
Brake fluid	110-171	230-340	300-319	572-606	1.2	8.5	232-288	111-142	460-550	238-288	5-6
Power steering fluid	175-180	347-356	360->382	680->720	1	7	309-348	588-658	507-523	945-973	>1
Motor oil	200-280	392-536	340-360	644-680	1	7	299-333	570-631	472-513	882-955	>1
Gear oil	150-270	302-510	>382	>716	1	7	316-371	601-700	>525	>977	>1
Automatic transmission fluid	150-280	302-536	330->382	626->716	1	7	239-242	462-468	507-523	945-973	>1
Ethylene glycol (antifreeze)	110-127	230-261	398-410	748-770	3.2	15.3	196-198	385-388			2.1
Propylene glycol (antifreeze)	93-107	199-225	371-421	700-790	2.6	12.5	187-188	369-370			2.6
Methanol (washer fluid)	11-15	52-55	464-484	867-903	6	36	65	149			1.1

^aFlash point data was obtained from Technical Data Sheets and Material Safety Data Sheets from manufacturers and suppliers of the major brands of each type of fluid available in the United States. The flash points of gasolines reported in these sources were determined by ASTM D 56. The flash points for diesel fuels, brake fluids, power steering fluids, motor oils, transmission fluids, gear oils, ethylene glycol (antifreeze), propylene glycol (antifreeze), and methanol were determined by ASTM D 56, ASTM D 92, or ASTM D 93.

Information Courtesy NFPA® 921

Gas	Autoignition Temperature		Flammability Limits (Vol. % fuel in air)		Boiling Point		Specific Gravity (Air)	
	°C	°F	LFL	UFL	°C	°F	Vapor Density (air =1)	Min. Ignition Energy (mJ)
Hydrogen	40-572	752-1061	4.0	75.0	-253	-422	0.07	0.018
Natural gas (methane)	632-650	1169-1202	5.3	15.0	-162	-259	0.60	0.280
Propane	450-493	842-919	2.2	9.5	-42	-44	1.56	0.250

Note: The data provided in this table are for generic or typical products and may not represent the values for a specific product. When possible, values specific to the product involved should be obtained from a material safety sheet, product specifications or by standard test methods.

Information Courtesy NFPA® 921

Table 25.3.3.1 Common Plastics Found in Motor Vehicles

Material	Ignition Temperature*		Melting Temperature		ΔH_c kJ/g	Peak Heat Release Rate† kW/m ²	Location in Vehicle
	°C	°F	°C	°F			
Acrylic fibers	560	1040	90–105	194–221	28	300	Floor covering
ABS	410	770	88–125	190–257	29	614–683	Body panels
Fiberglass (polyester resin)	560	1040	428–500	802–932			Resin burns but not glass body panels
Nylons	413–500	775–932	220–265	428–509	28	517–593	Trim, window gears, timing gears, HVAC unit, structure
Polycarbonate	440–522	824–972	265	510	22	16	Instrument panel, structure, headlights
Polyethylene	270–443	518–830	115–137	240–280	40	453–913	Wiring insulation, fuel tank, battery cover
Polypropylene	250–443	482–829	160–176	320–350	43	377–1170	Resonator, structure, air ducts, HVAC unit, battery cover
Polystyrene	346–365	655–689	120–240	248–465	36	723	Insulation, padding, trim
Polyurethanes	271–378	520–712	120–160	248–320	18	290	Seats, arm rests, padding, trim
Vinyl (PVC)	250–430	482–806	75–105	167–221	11	40–102	Wire insulation, upholstery, HVAC unit, bulkhead insulation

*Piloted ignition temperature. Typically, the autoignition temperature (AIT) is higher than the piloted ignition temperature.

† At an incident radiant heat flux of 20 kW/m² in the cone calorimeter by ASTM E 1354.

Lide (ed.), *Handbook of Chemistry and Physics*.

Hilado, *Flammability Handbook for Plastics*.

ASM Engineered Materials Reference Book, 2nd Ed., M. Baucchio ed. ASM Int'l, Materials Park, OH, 1994.

NFPA Fire Protection Handbook, Tables 3.13A and A.6 (17th edition).

Babrauskas, V. *Ignition Handbook*, Table 15, Fire Science Publishers, Issaquah, WA, 2003.

Cole, L., *Investigation of Motor Vehicle Fires*. Lee Books. Novato, CA: 1992.

Harper, Charles, *Handbook of Building Materials for Fire Protection*, McGraw-Hill Handbooks, 2004.

Note: The data provided in this table are generic and may not represent the values for a specific product. Thermal and combustion properties depend on composition, thickness and/or orientation. When possible, values specific to the product involved should be obtained from the manufacturer or by laboratory testing.

Case or File # _____ Date: _____ Time: _____
Vehicle Year: _____ Make: _____ Model: _____
Body Style: [] 2DR [] 4DR [] Pickup [] Van [] SUV [] SW Other: _____
Tag Number: _____ State of Issue: _____ Expiration Date: _____
Vehicle Identification Number: _____

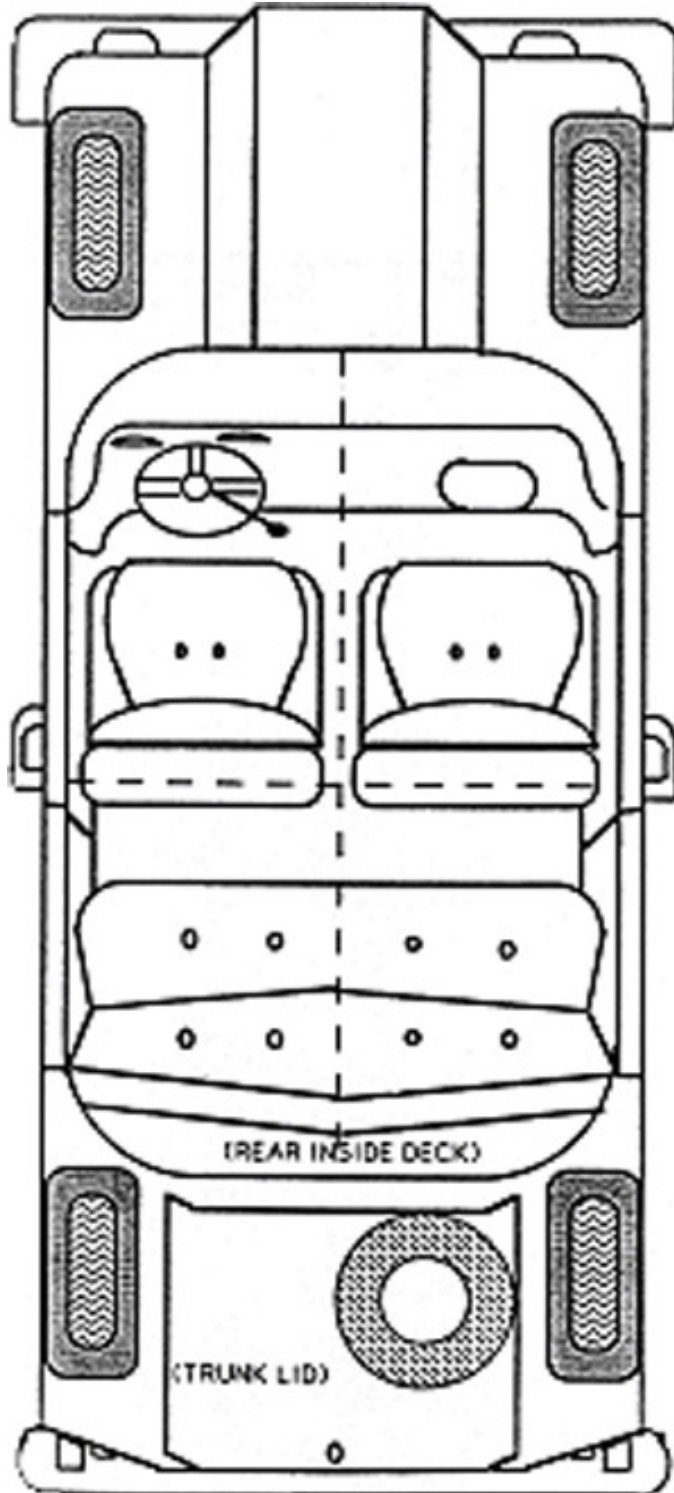

Case or File # _____ Date: _____ Time: _____
Vehicle Year: _____ Make: _____ Model: _____
Body Style [] 2DR [] 4DR [] PICKUP [] VAN [] SUV [] SW OTHER: _____
Tag Number: _____ State of Issue: _____ Expiration Date: _____
Vehicle Identification Number: _____

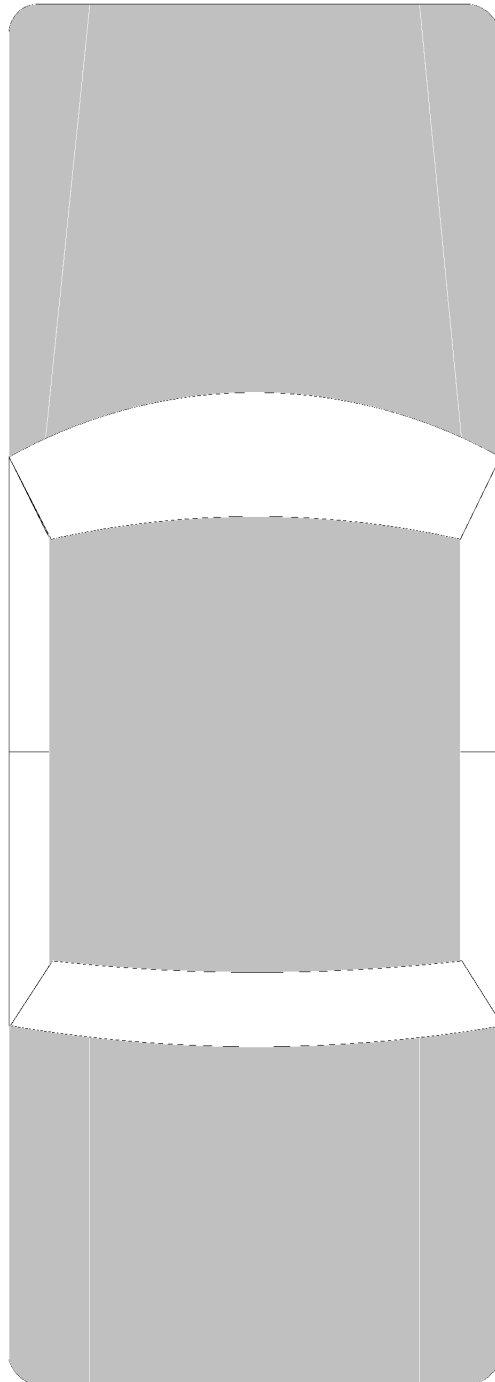

VEHICLE FIRE REPORT

Case or File: _____ Owner: _____

Address: _____
(Street or P.O. Box) (City) (State) (ZIP)

Date of Loss: _____ Location of Loss: _____

Make of Vehicle: _____ Year: _____ Model: _____

Vehicle Identification Number: _____

Tag Number: _____ Year: _____ Expiration: _____ State: _____

(Circle Origin & Extent of Burning)

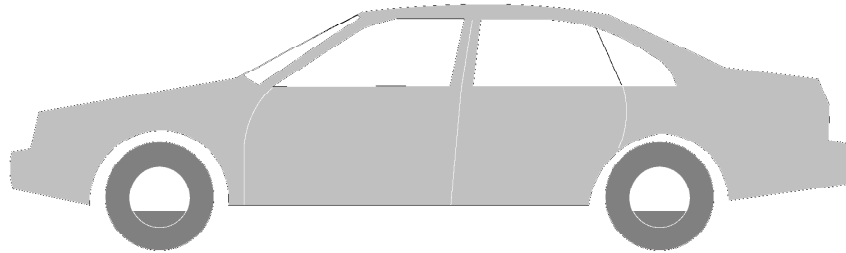
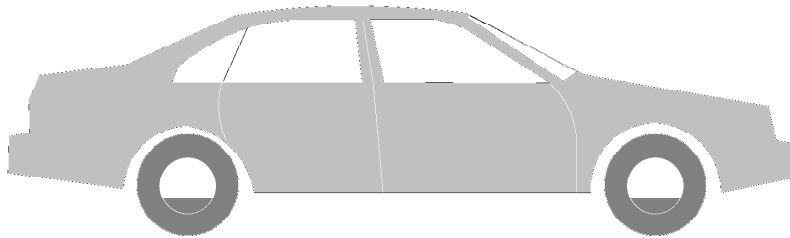
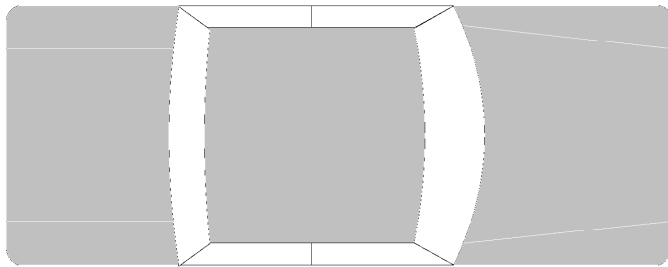

Case or File # _____ Date: _____ Time: _____
Vehicle Year: _____ Make: _____ Model: _____
Tag Number: _____ Expiration Date: _____
State: _____ VIN: _____
Investigator: _____

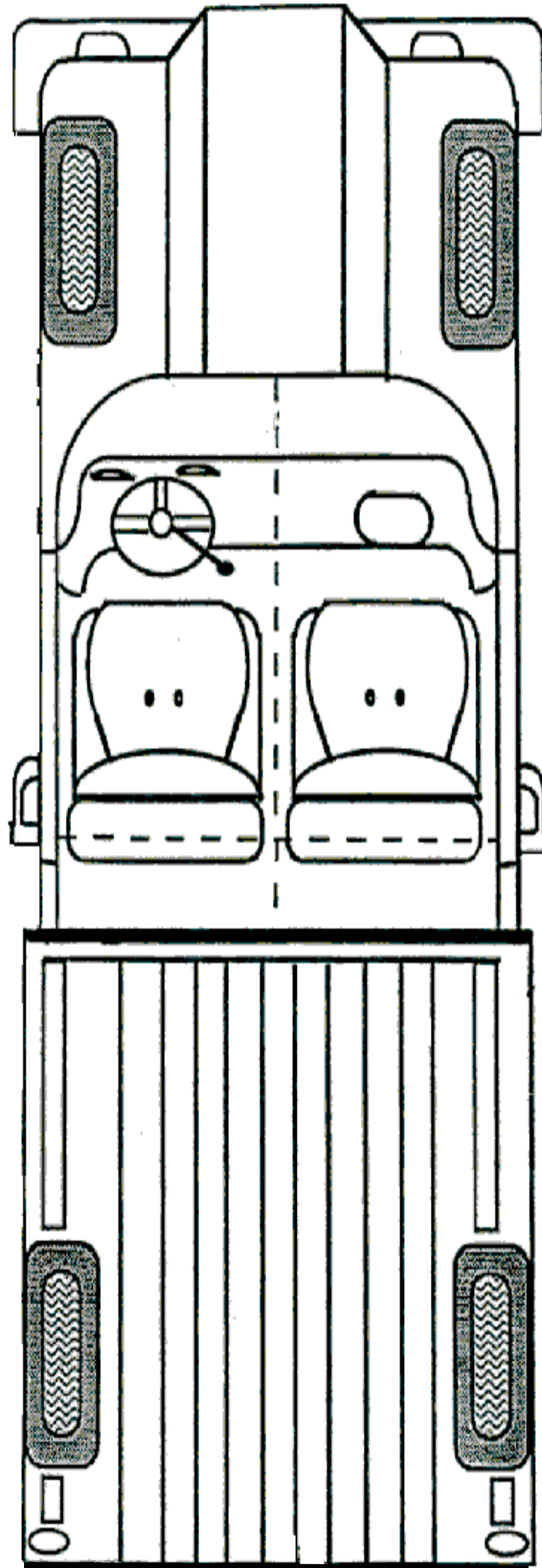

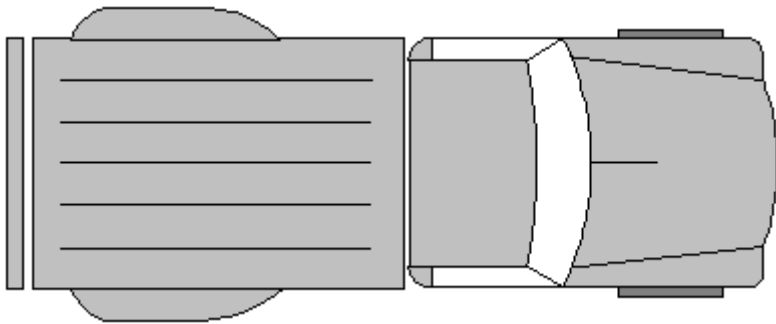
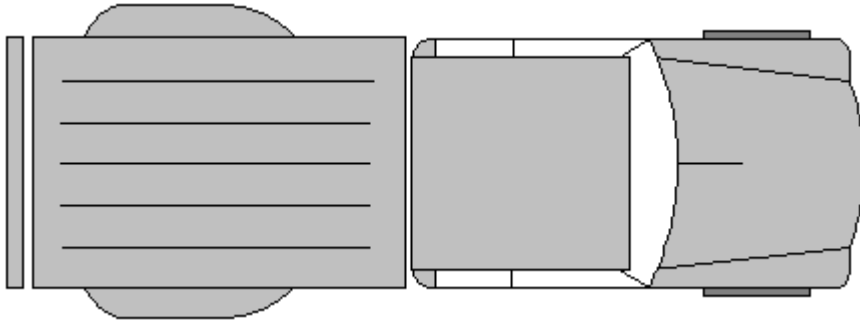
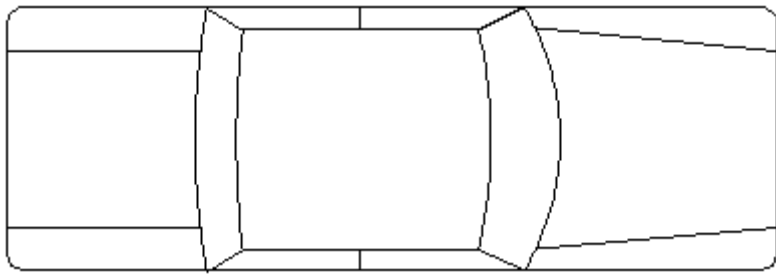
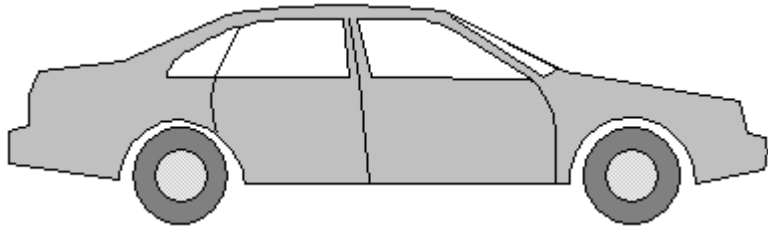
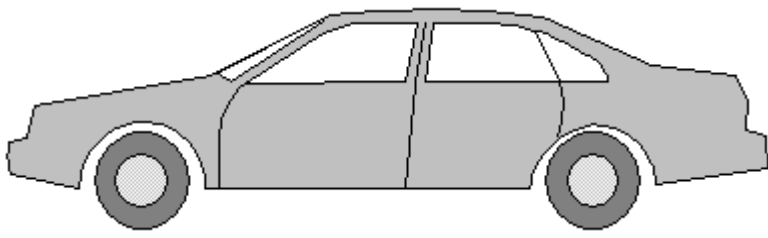

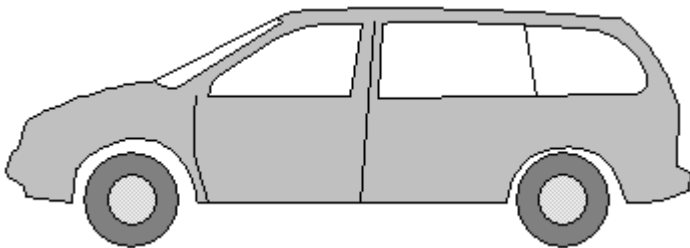
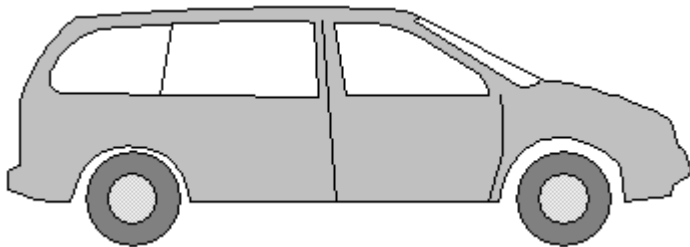
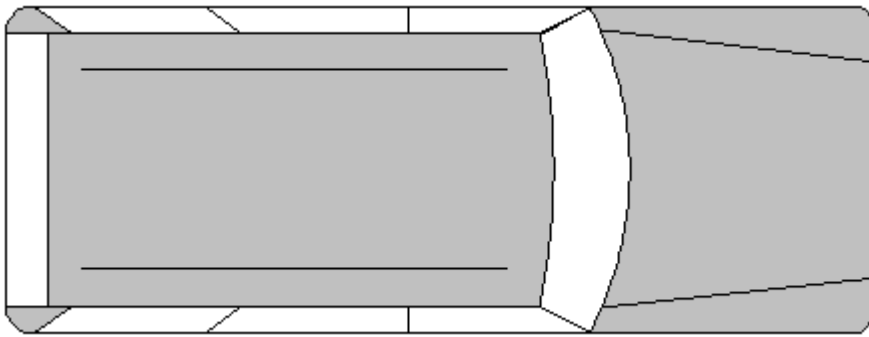
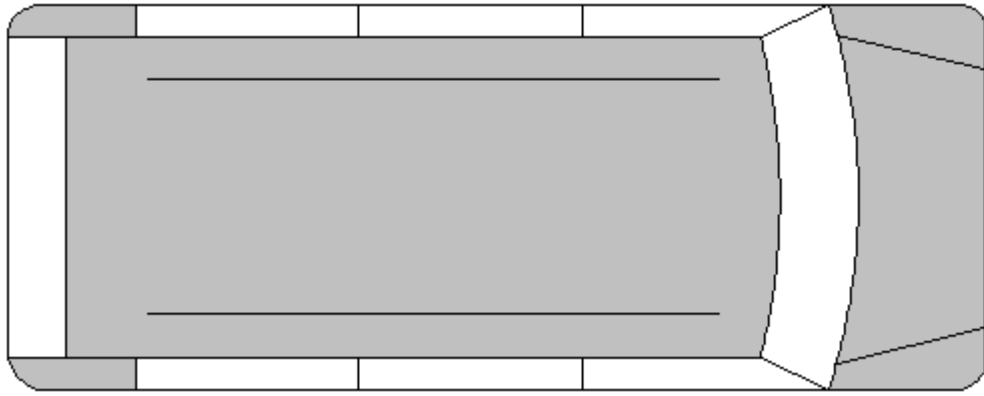
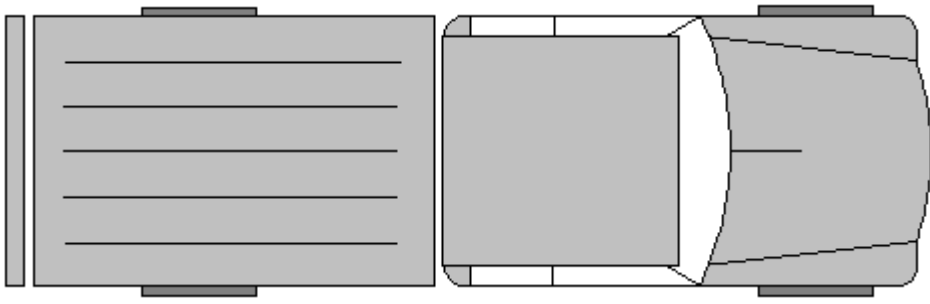

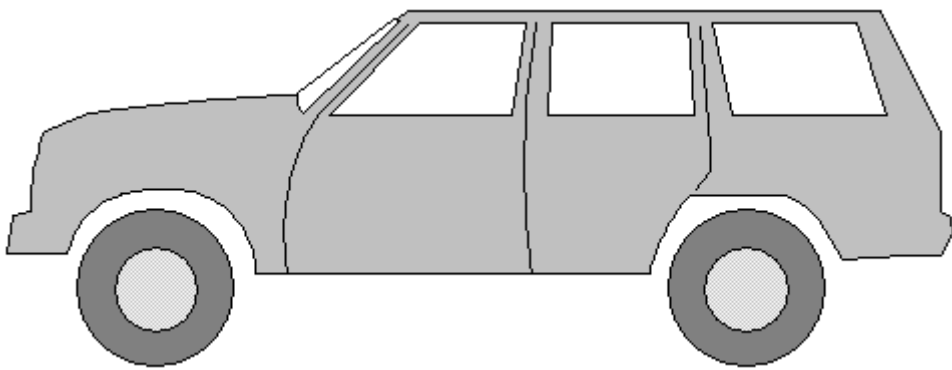
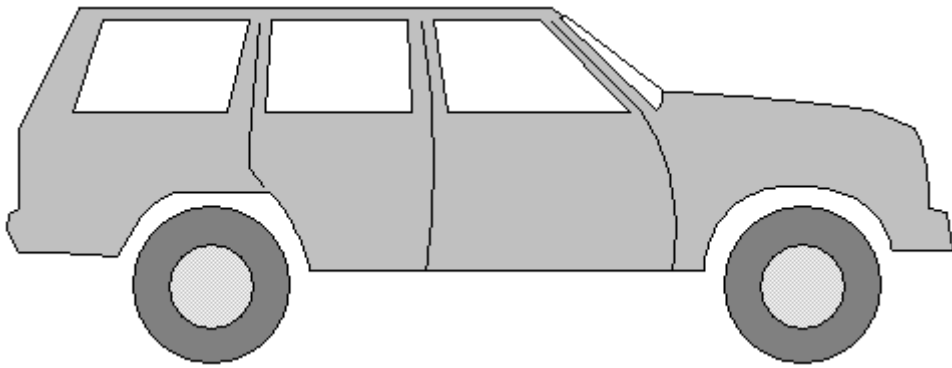
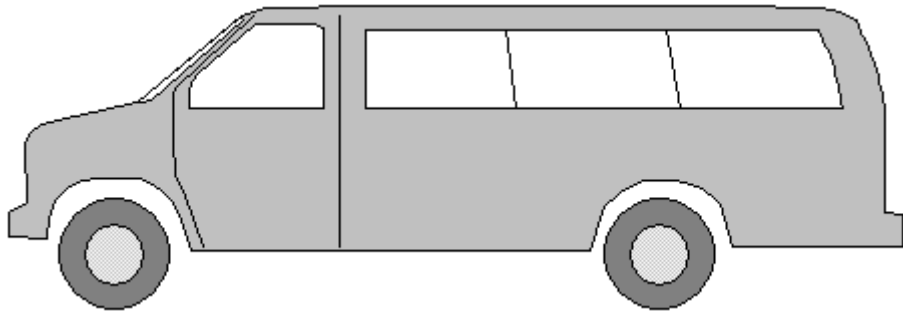
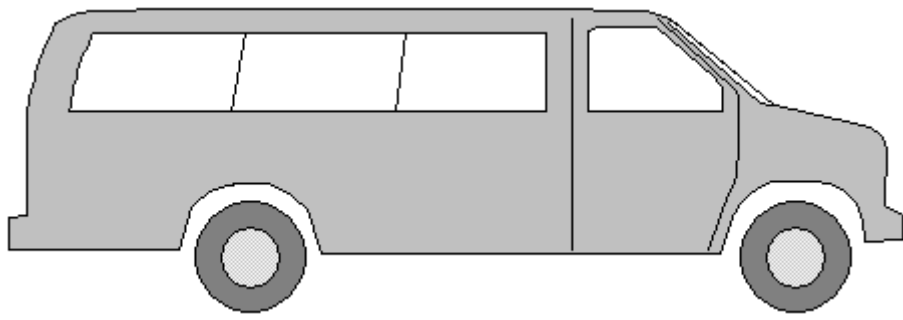

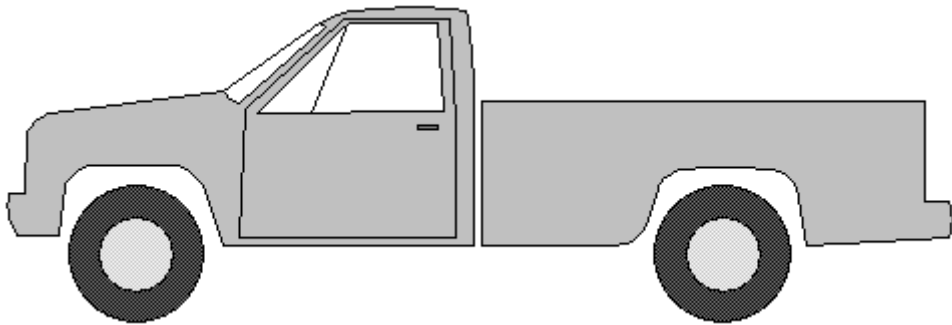
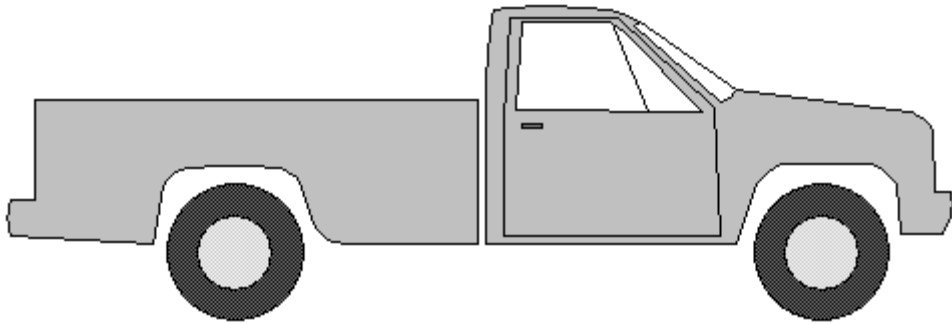
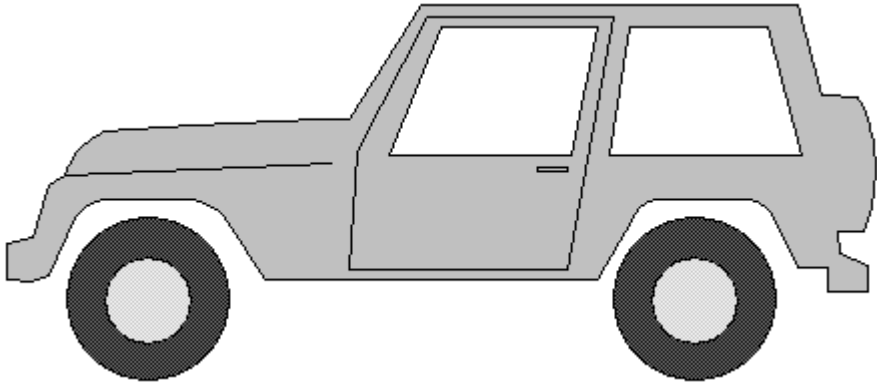
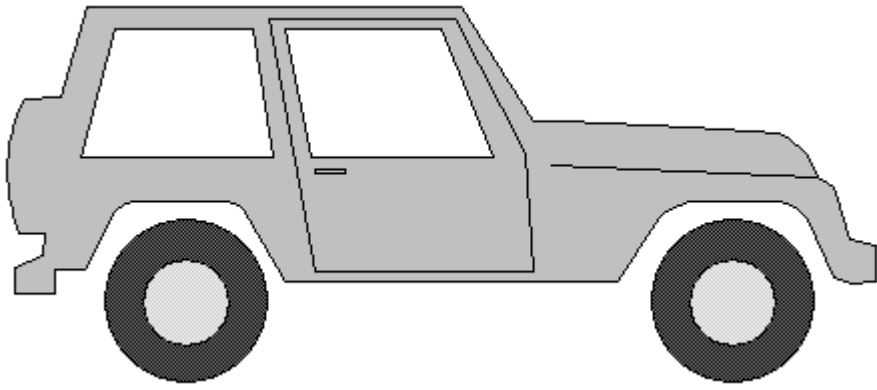

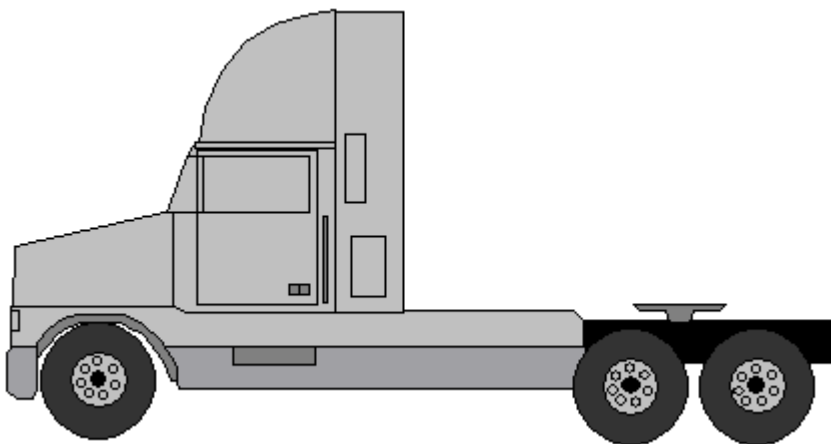
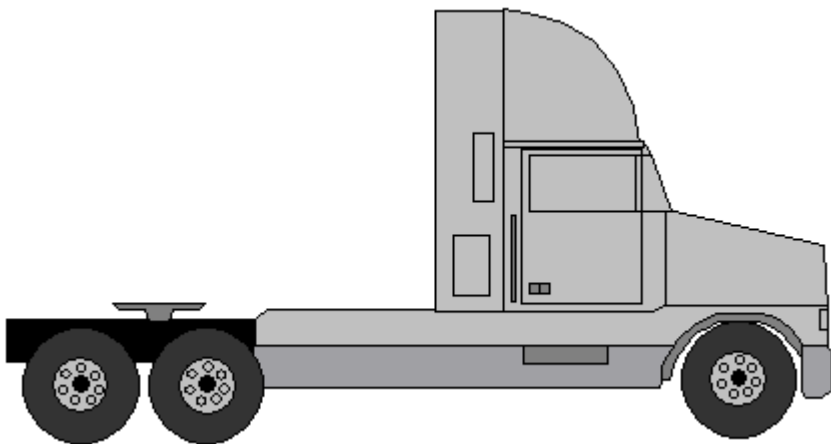
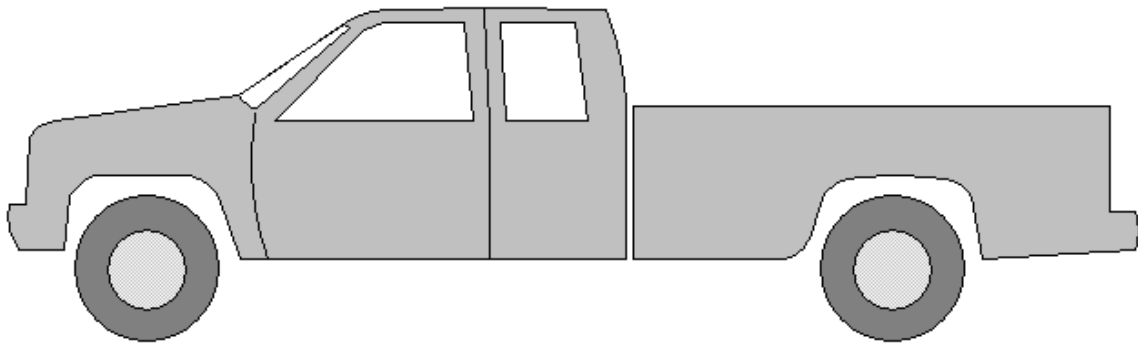
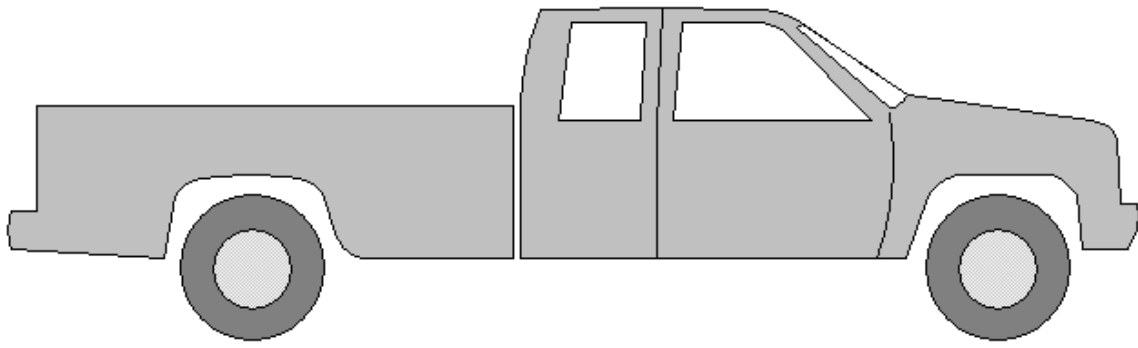

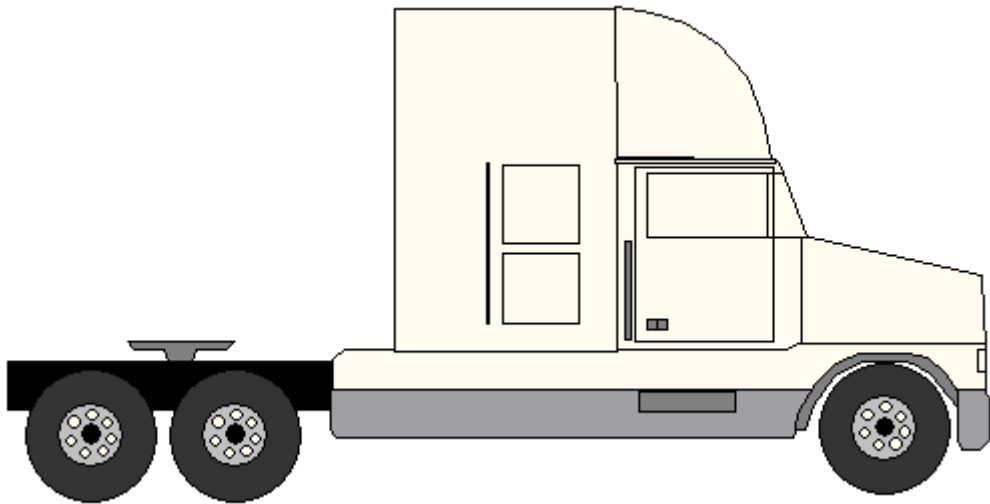
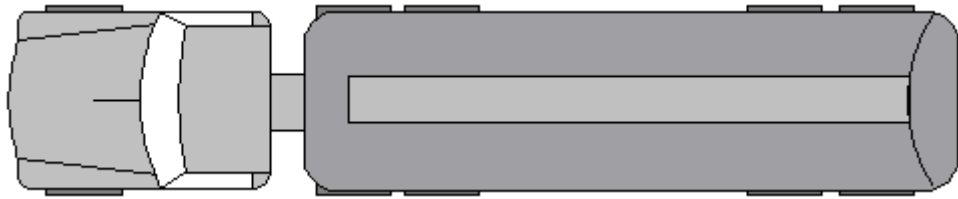
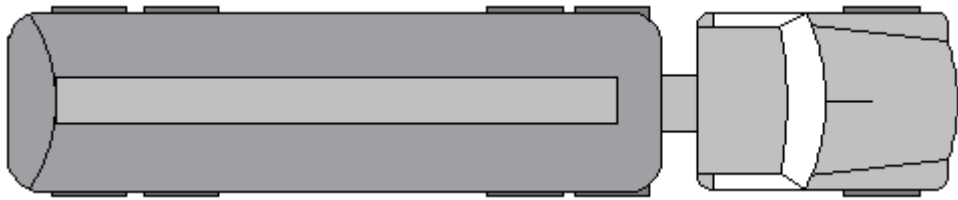
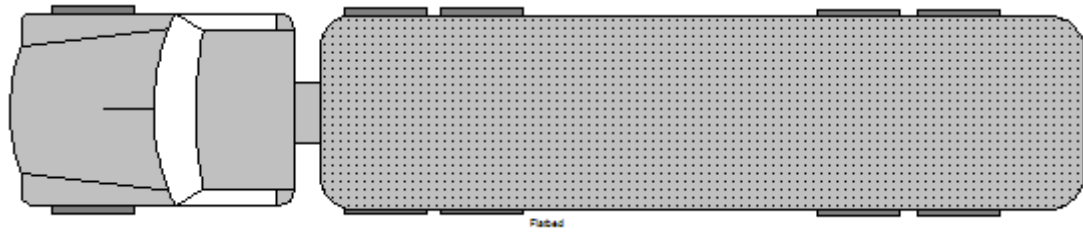
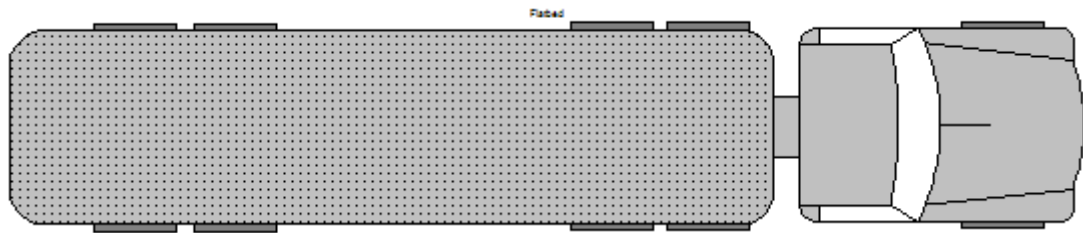

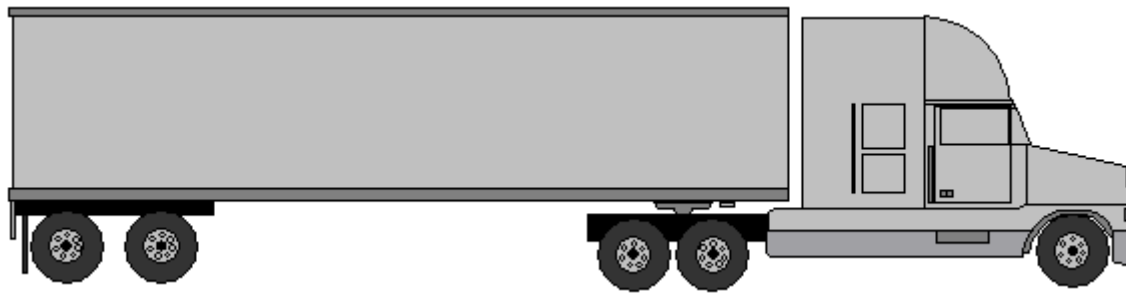
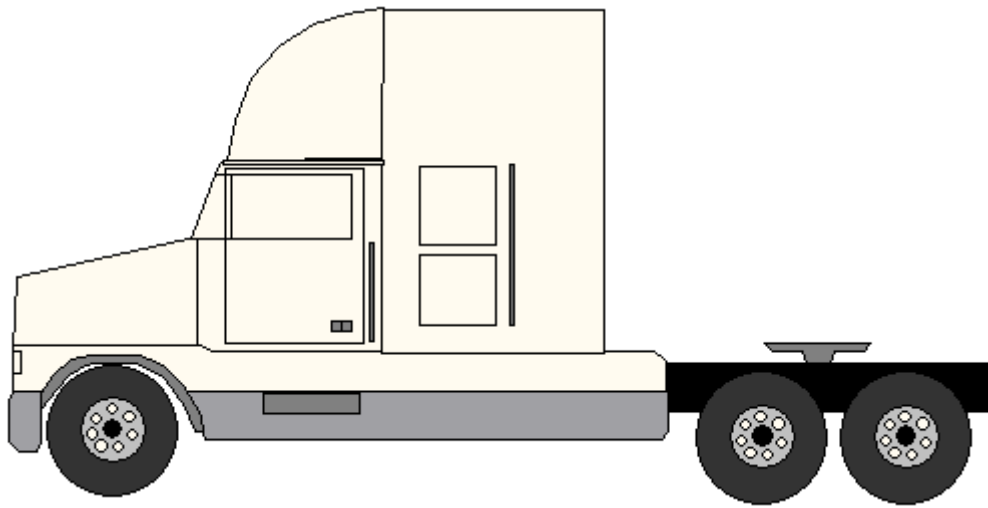

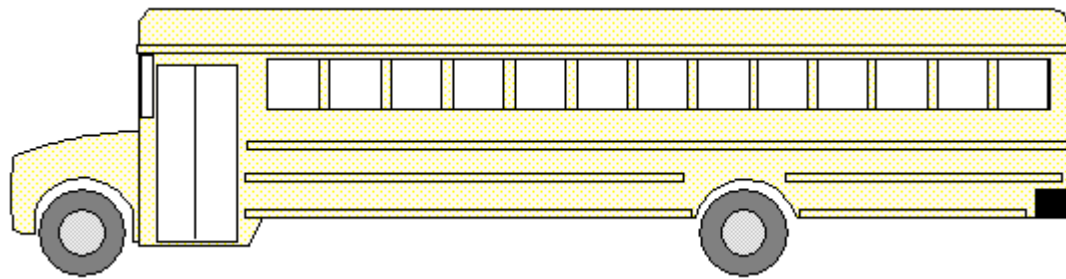
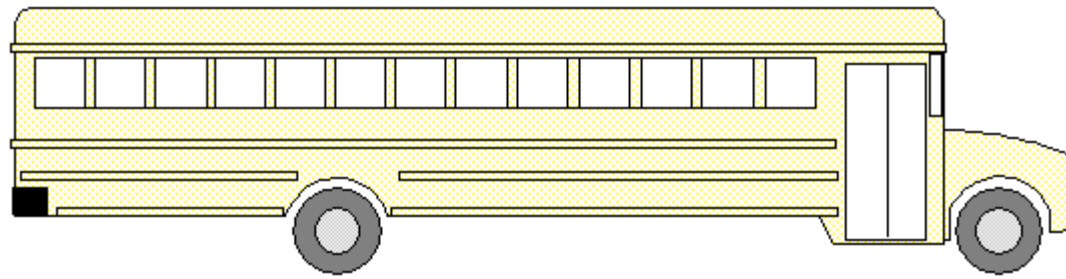
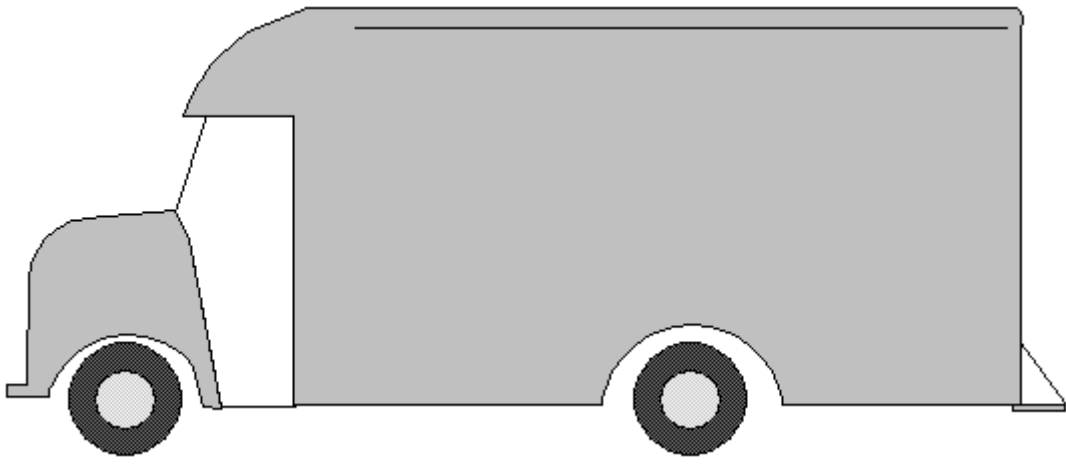
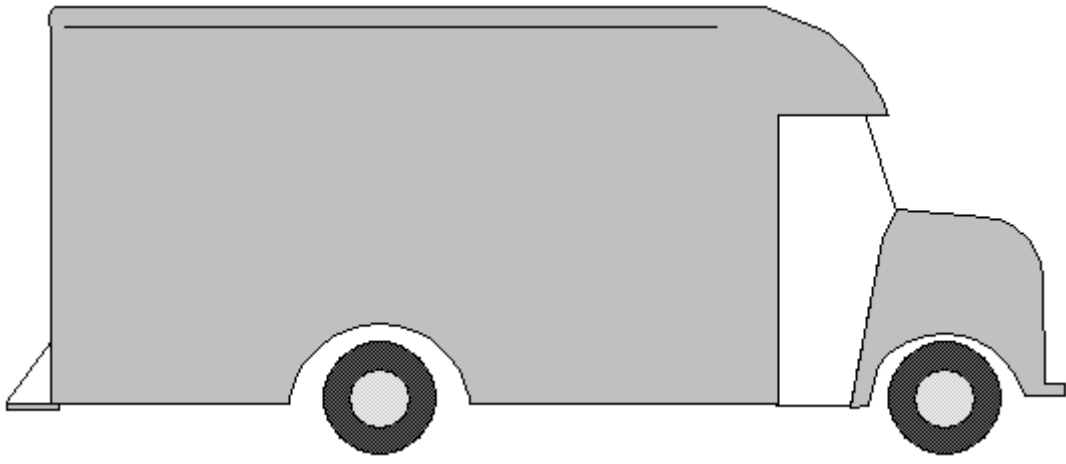

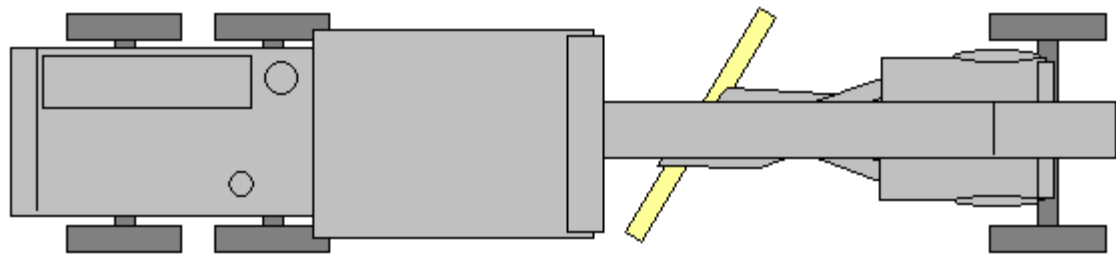
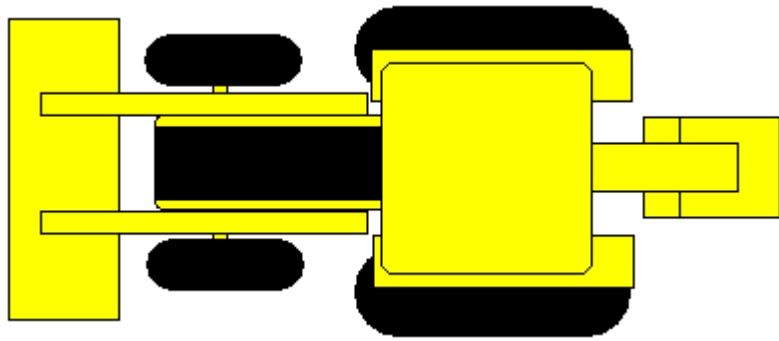
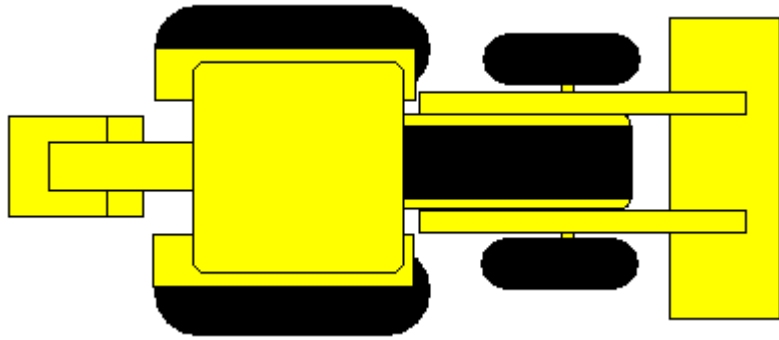
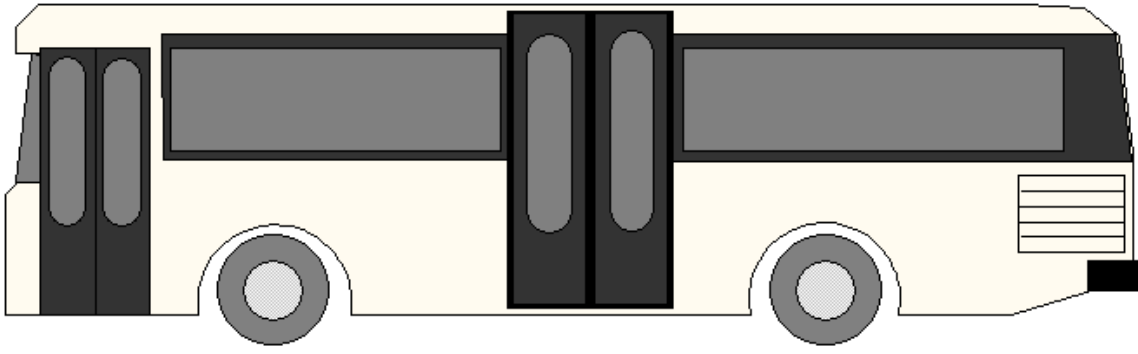
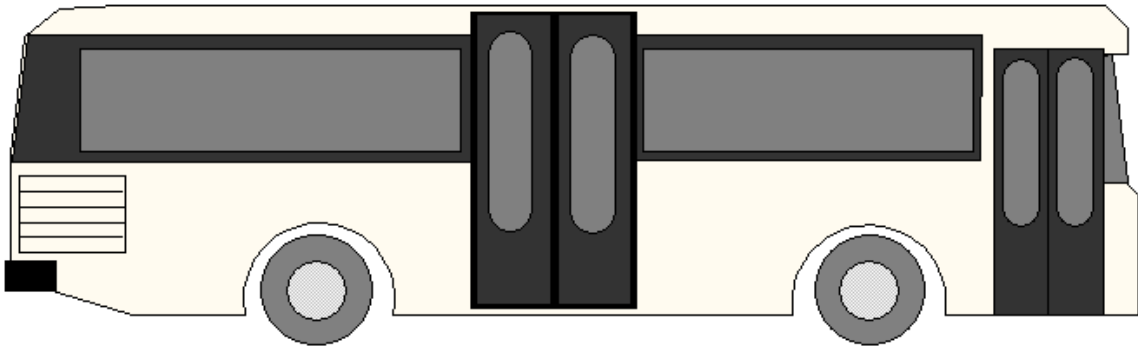

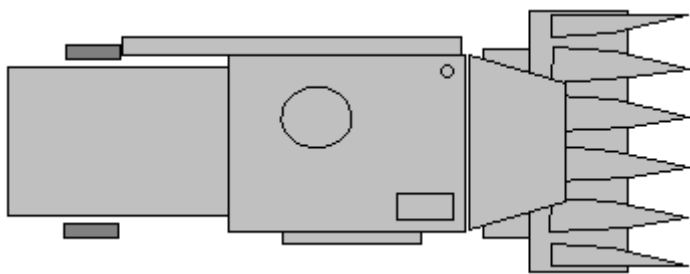
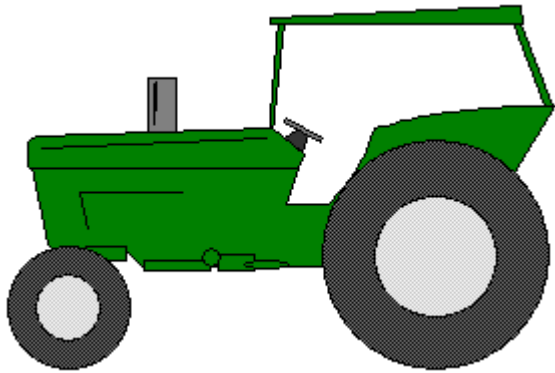
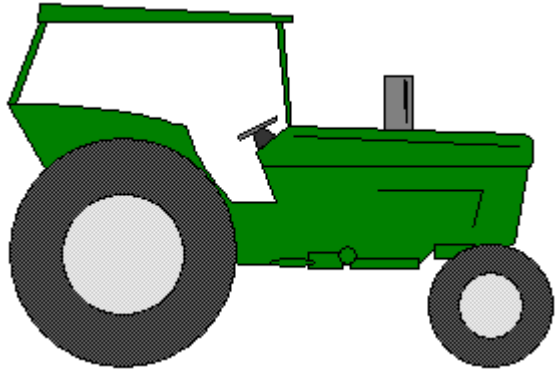
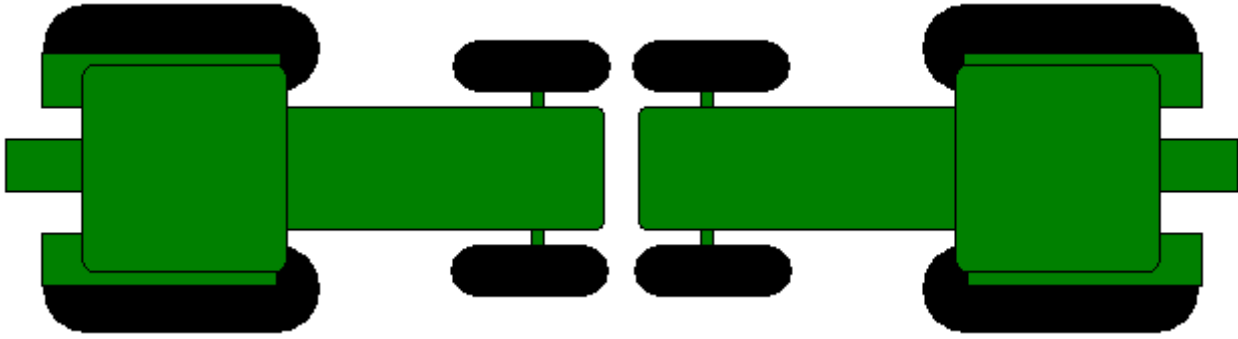
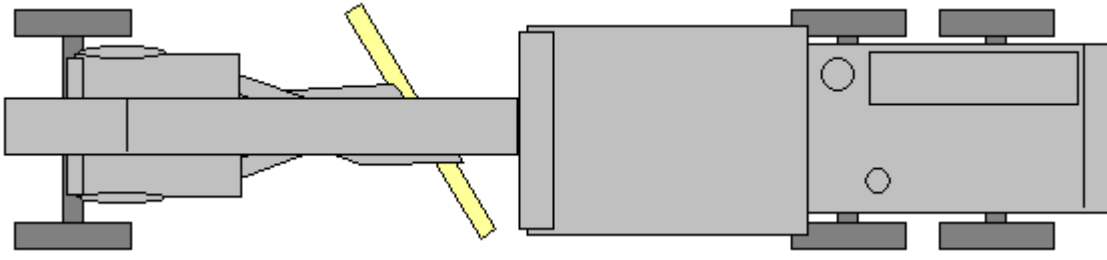

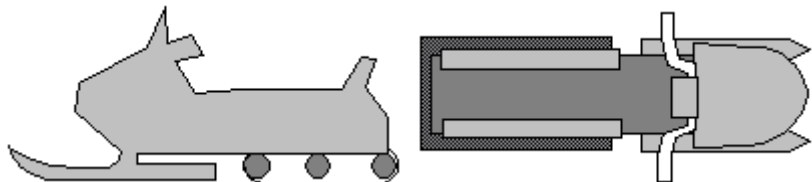
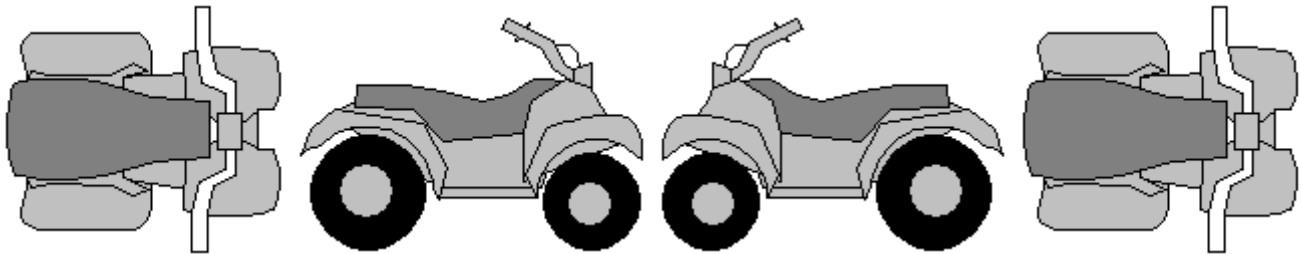
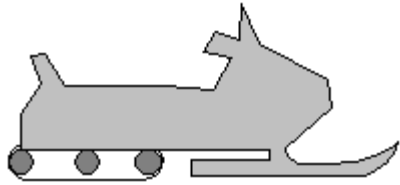
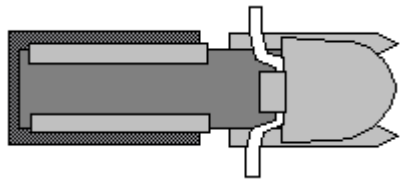
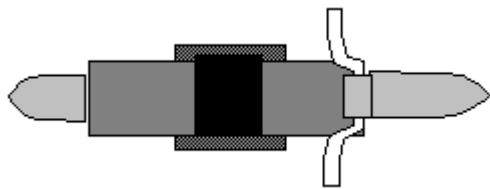
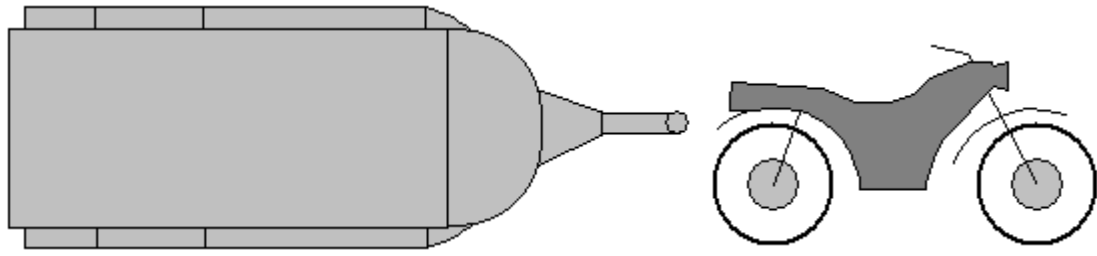
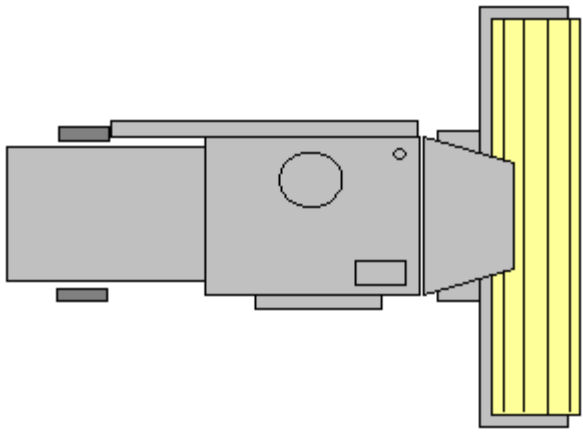

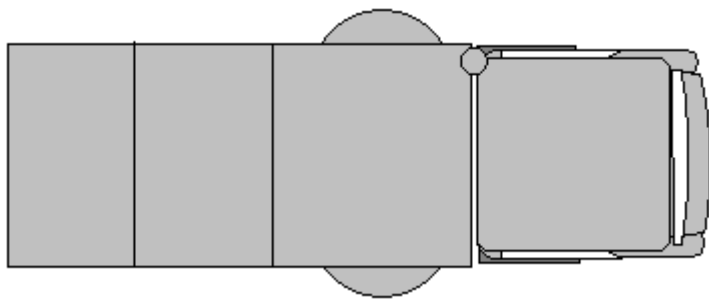
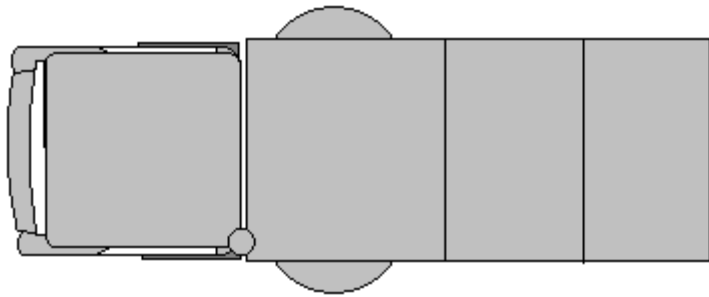
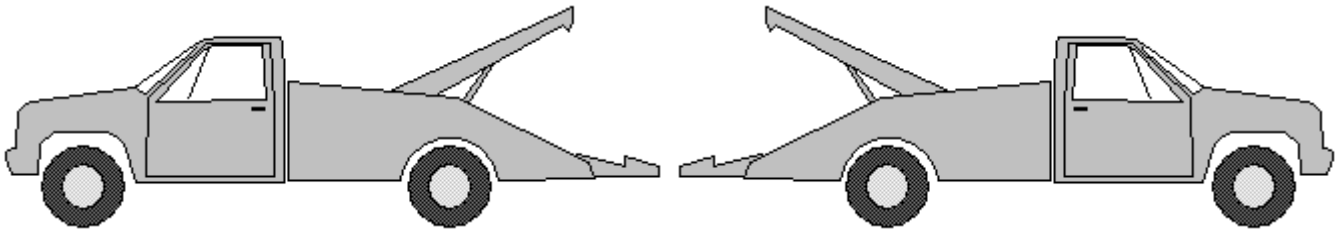
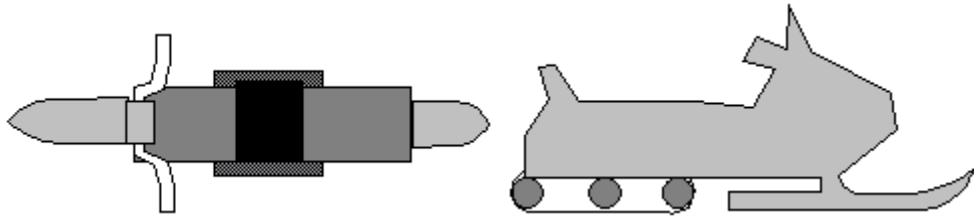
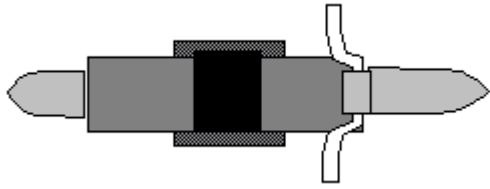
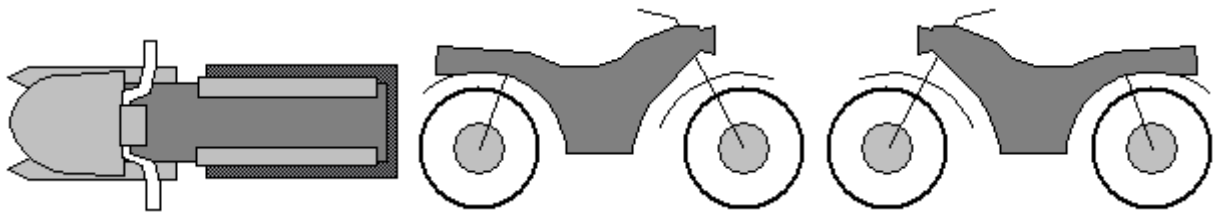

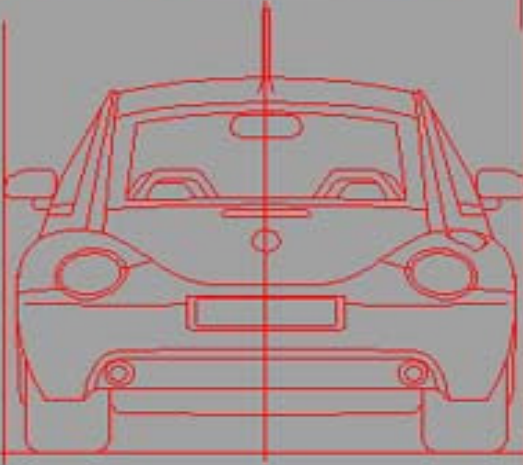
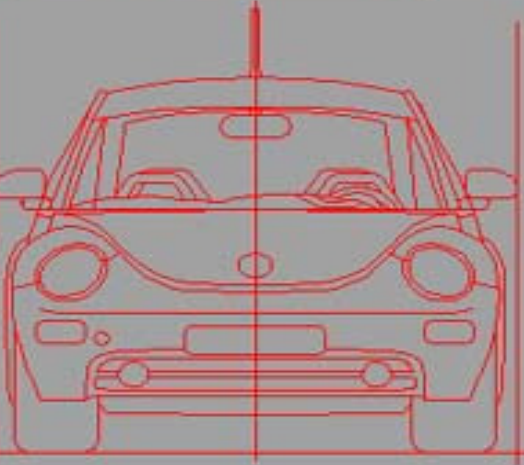
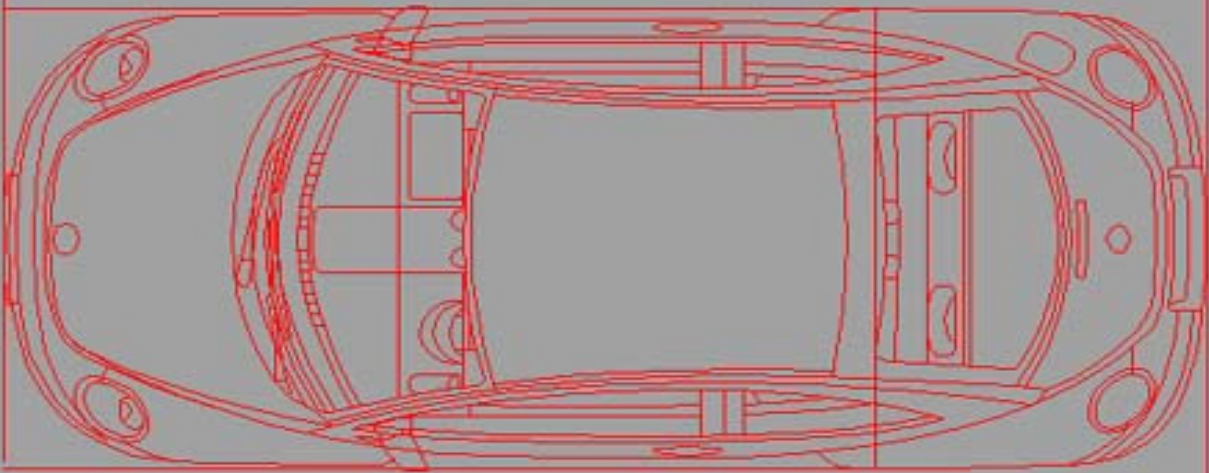
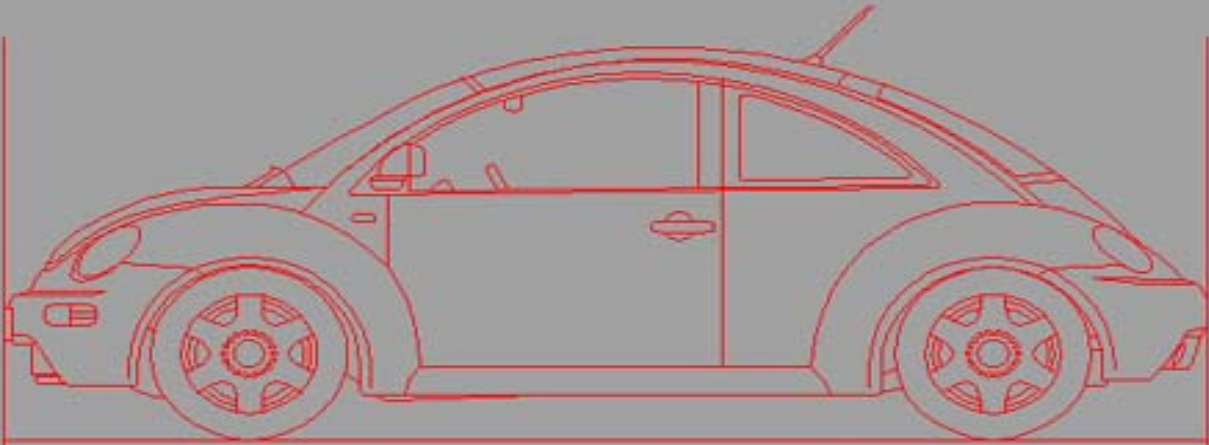

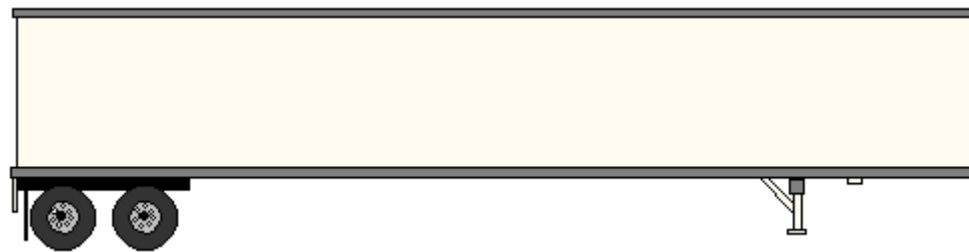
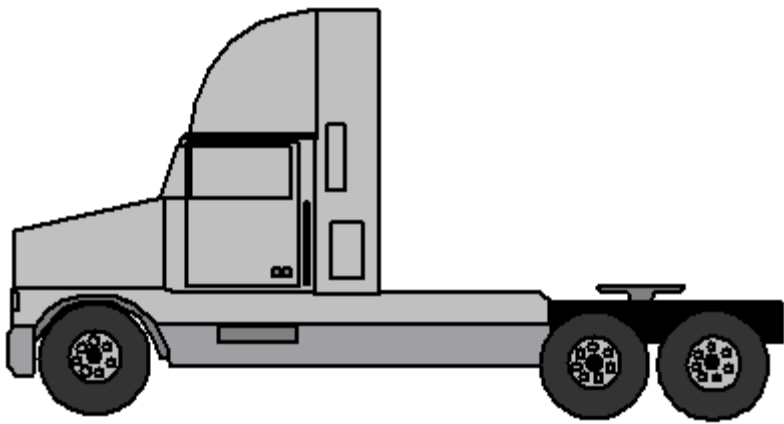
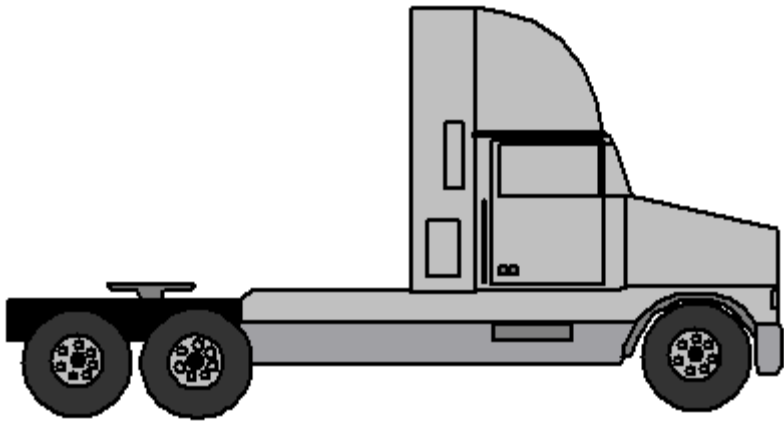

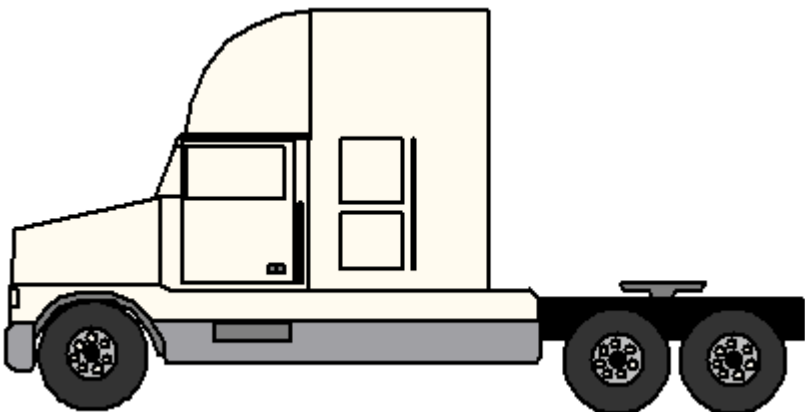
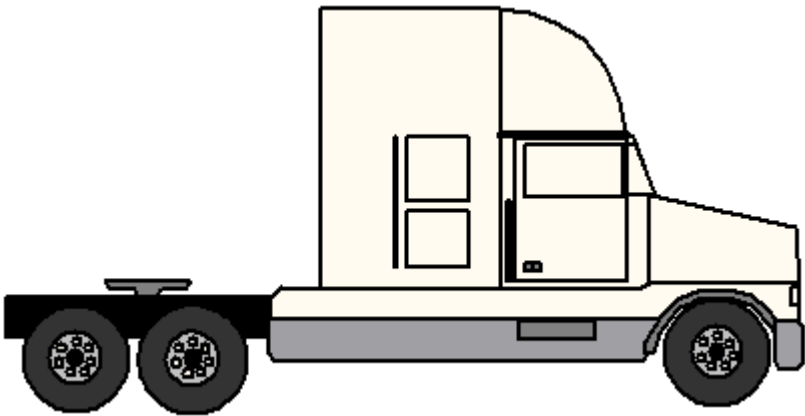
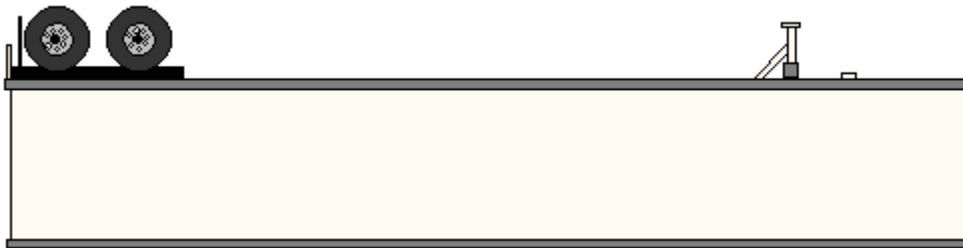
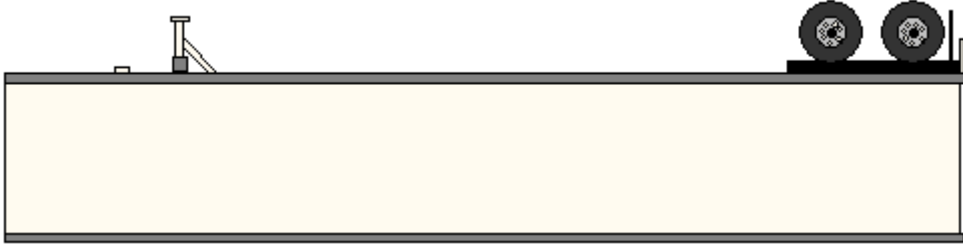
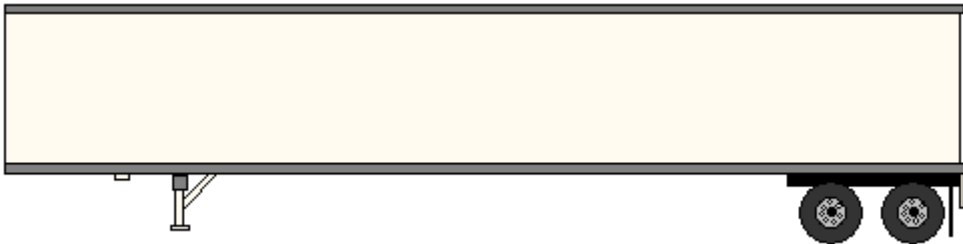

Flat bed

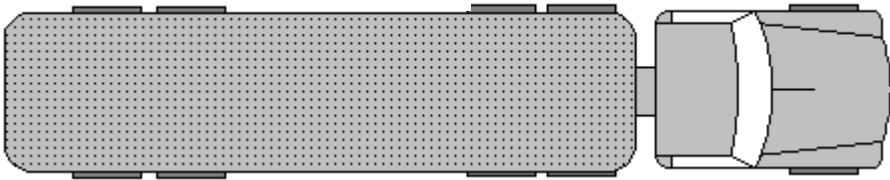

Flat bed

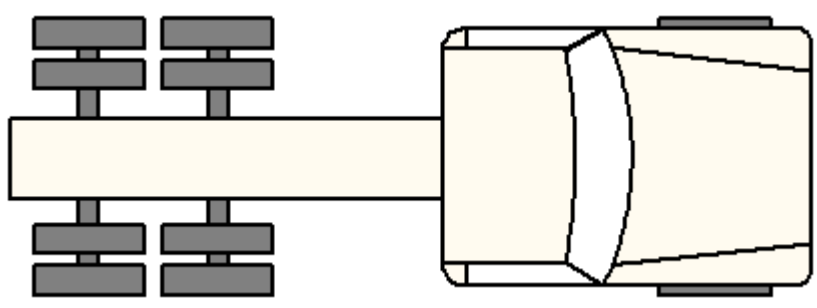
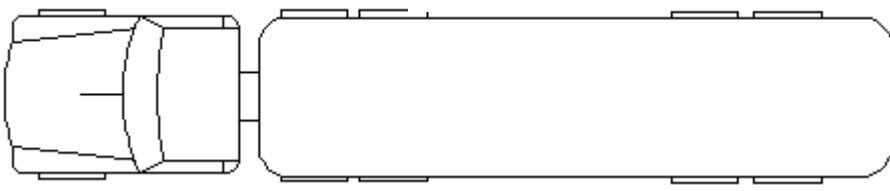

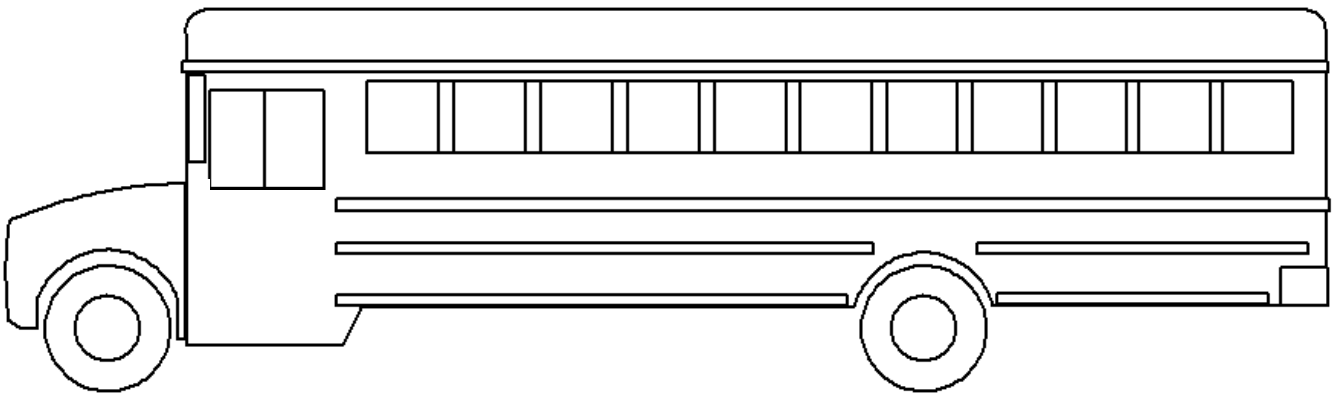
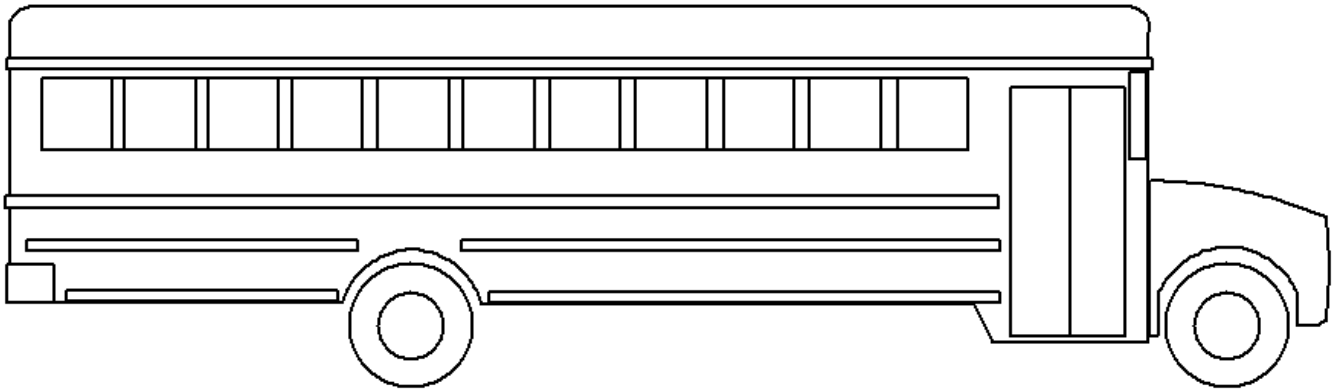
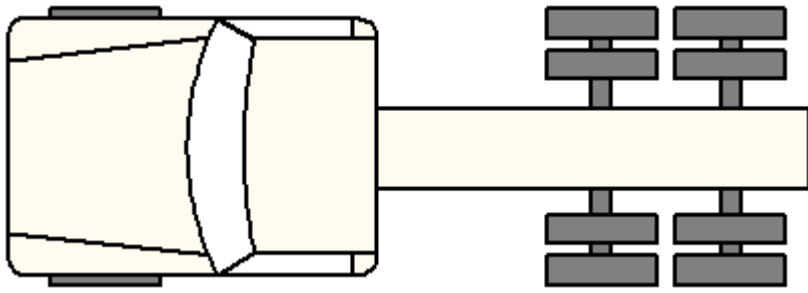

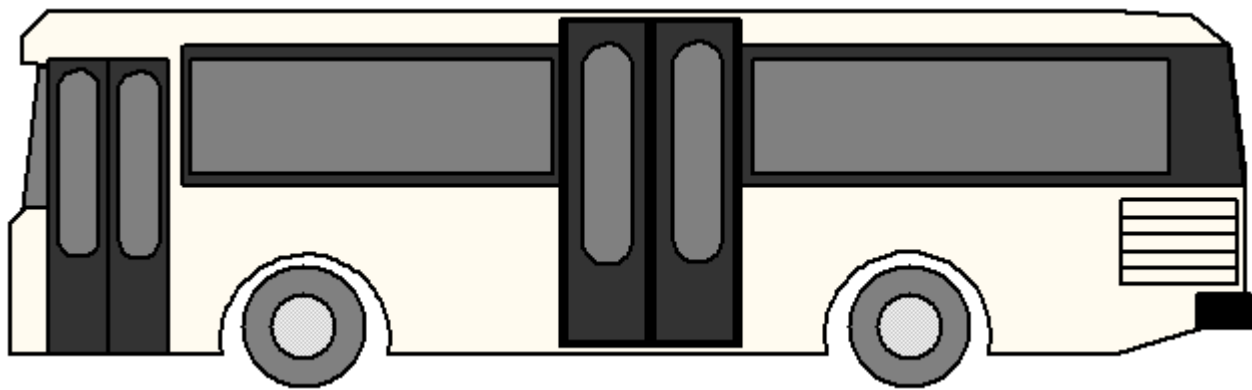
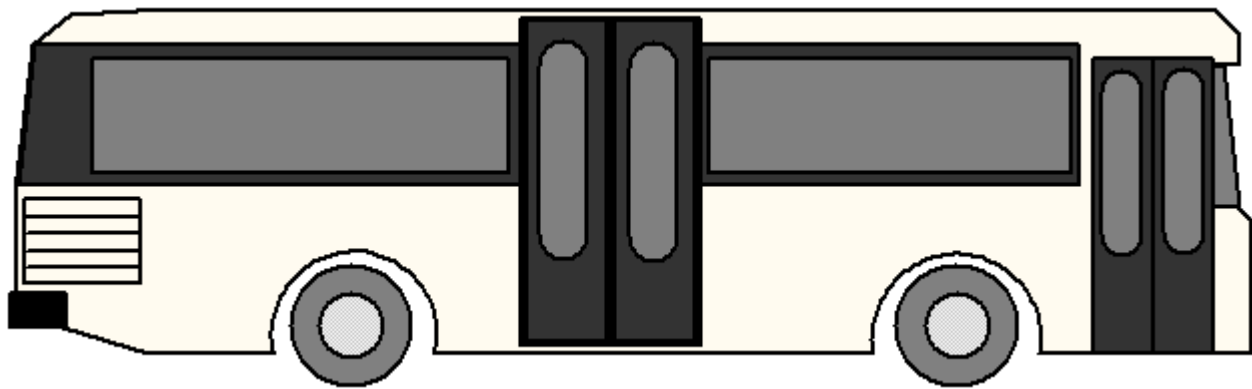

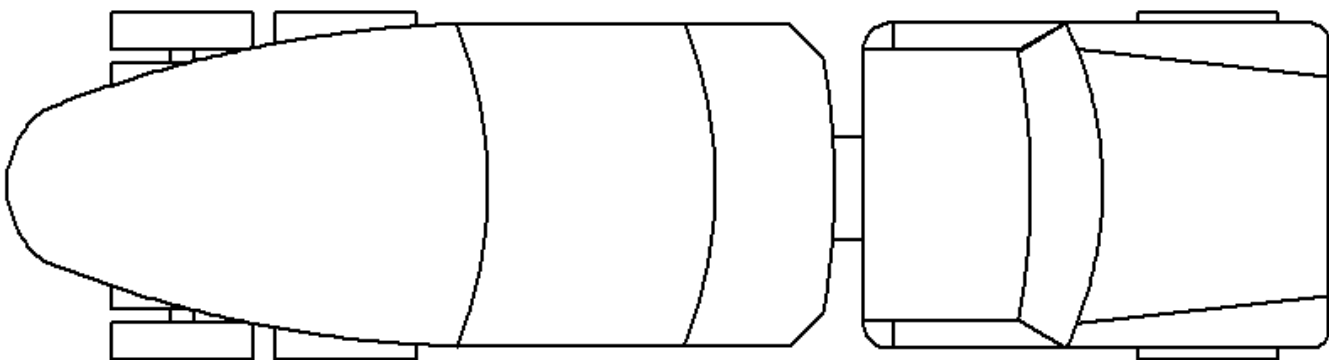
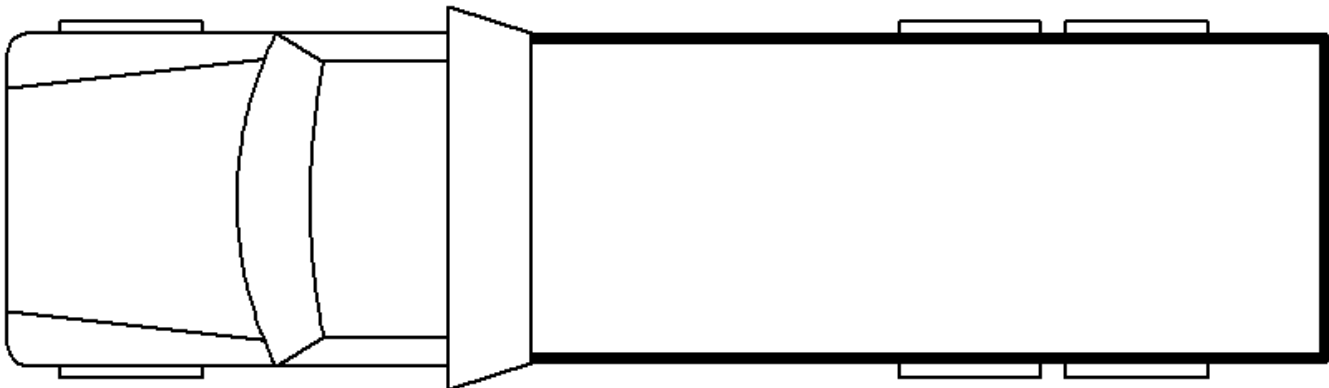
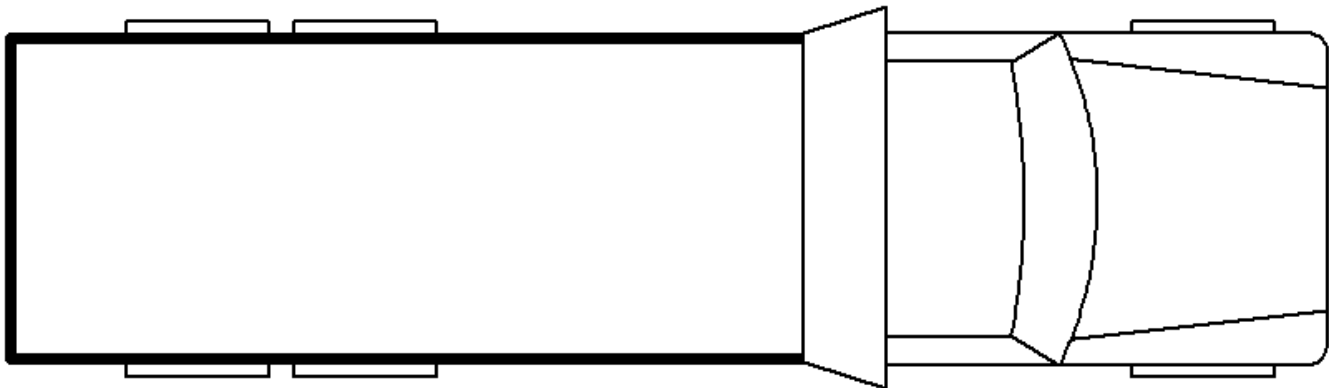

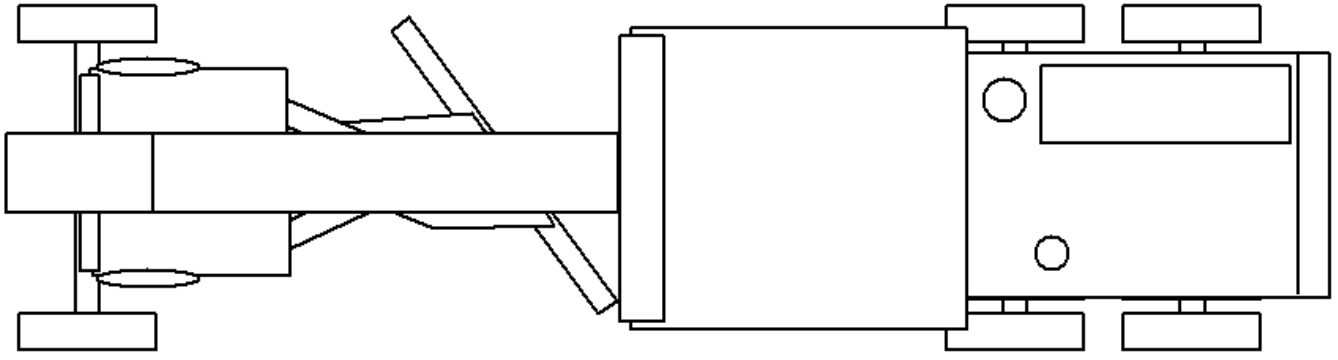
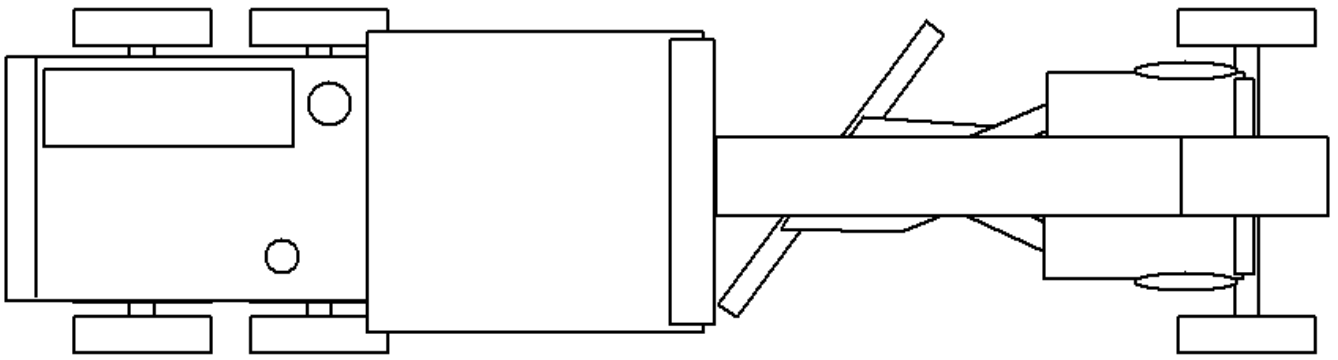
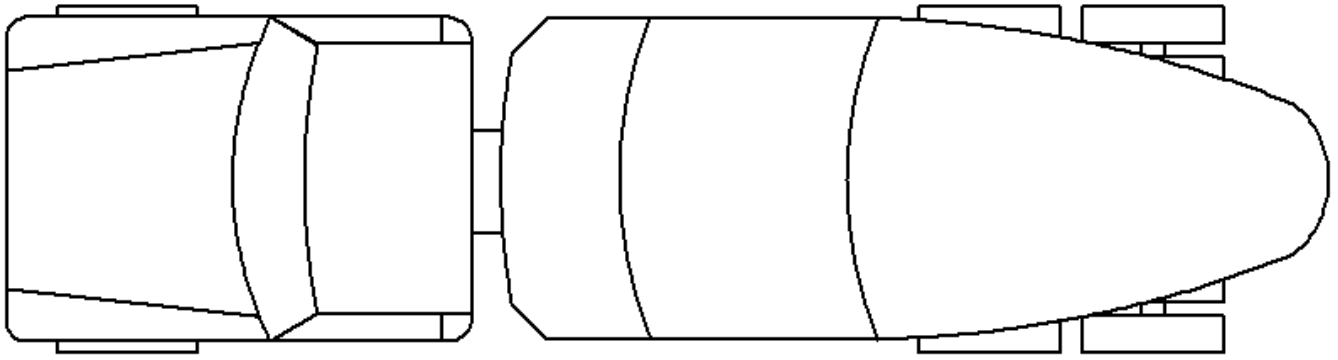

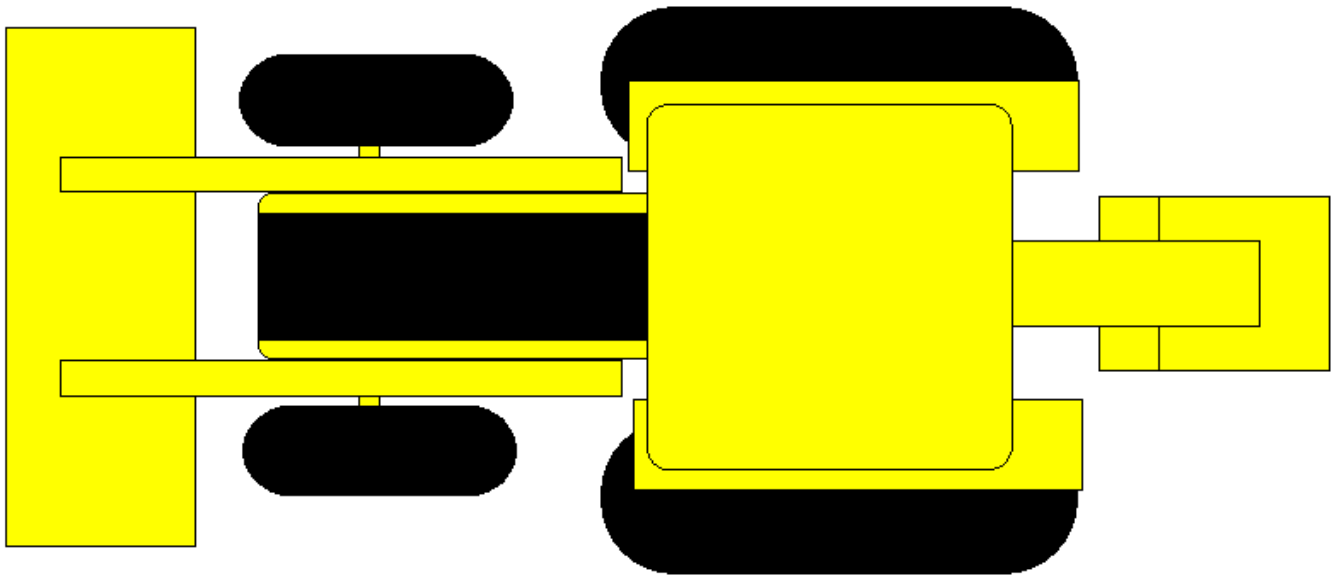
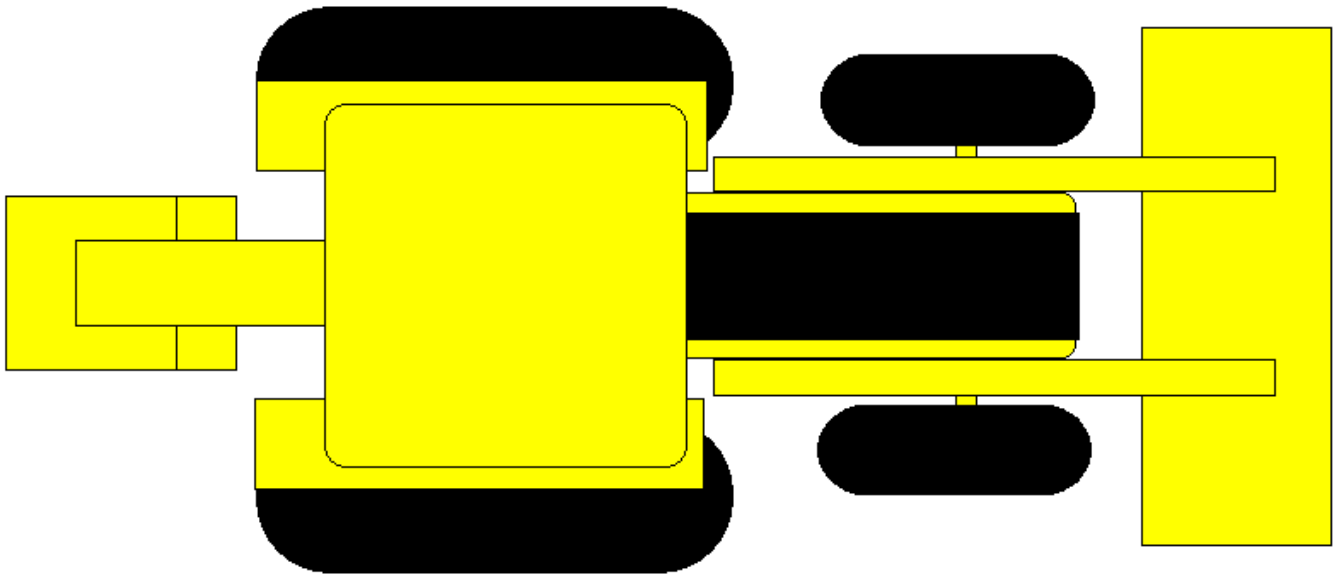

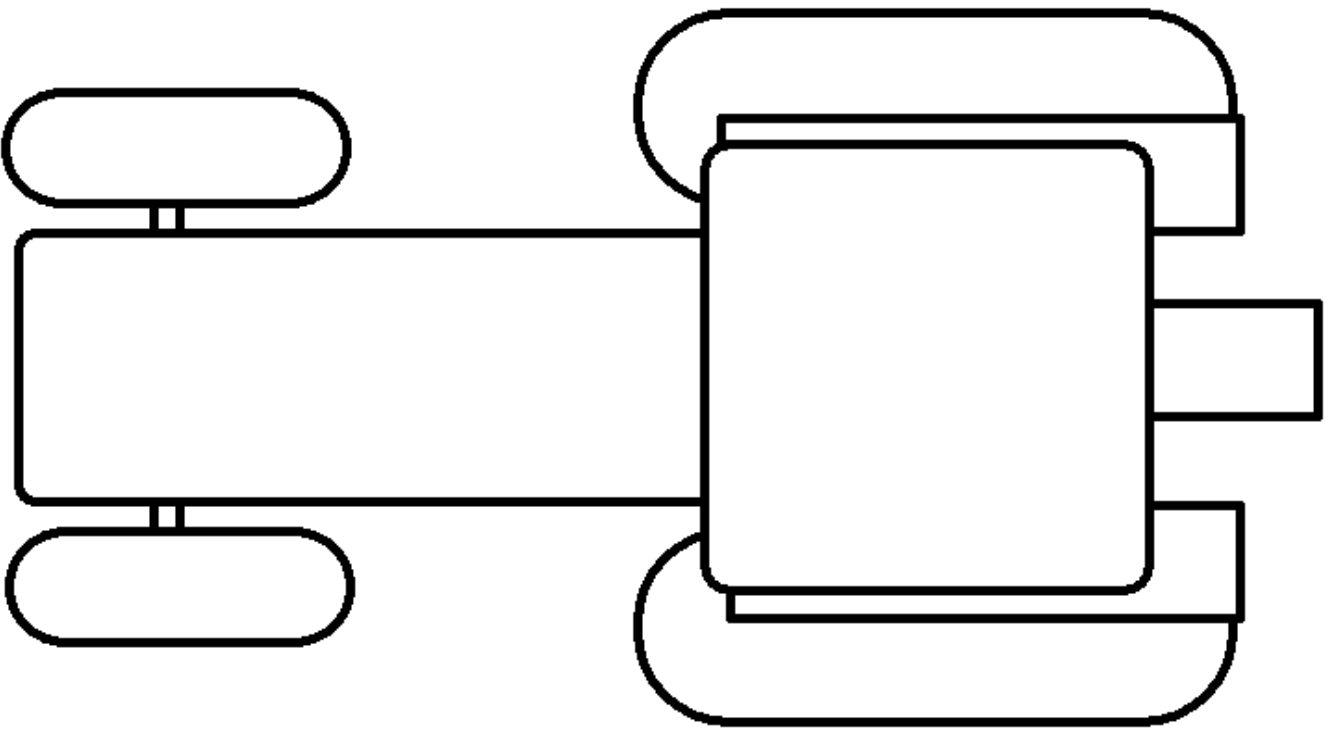
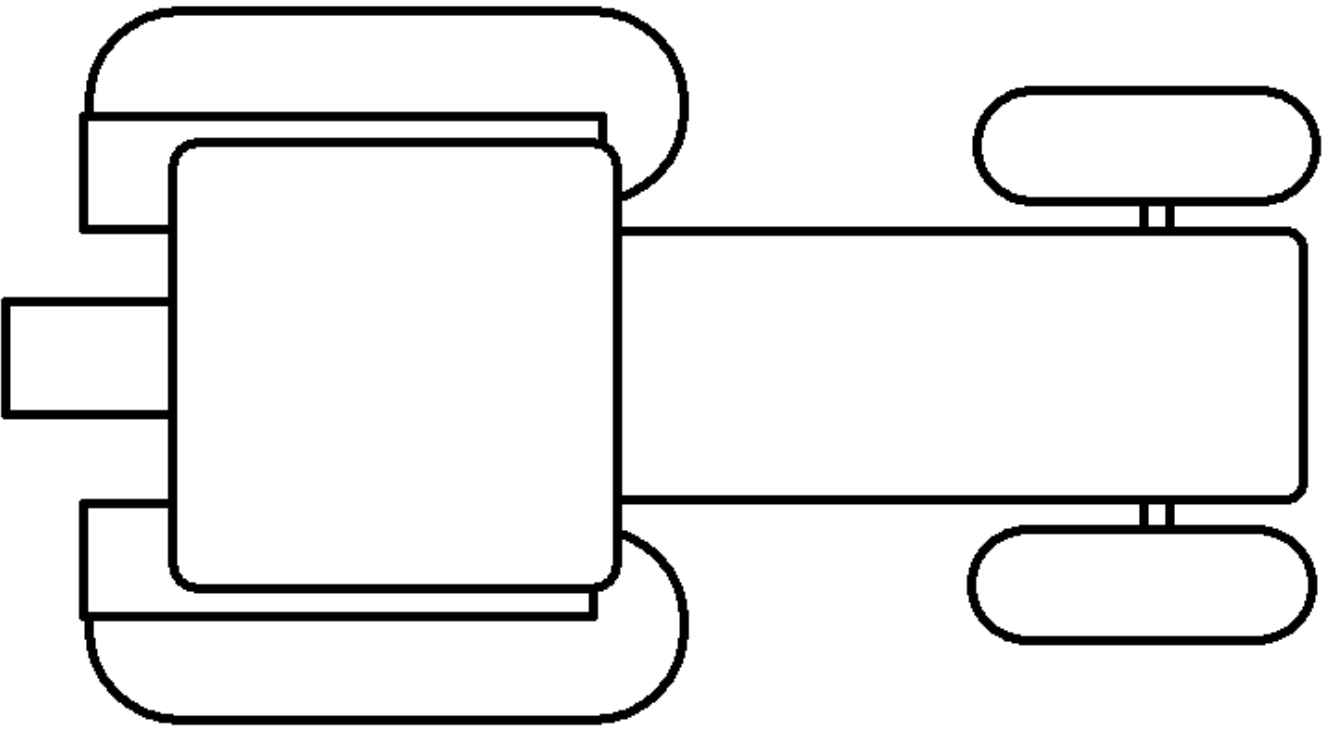

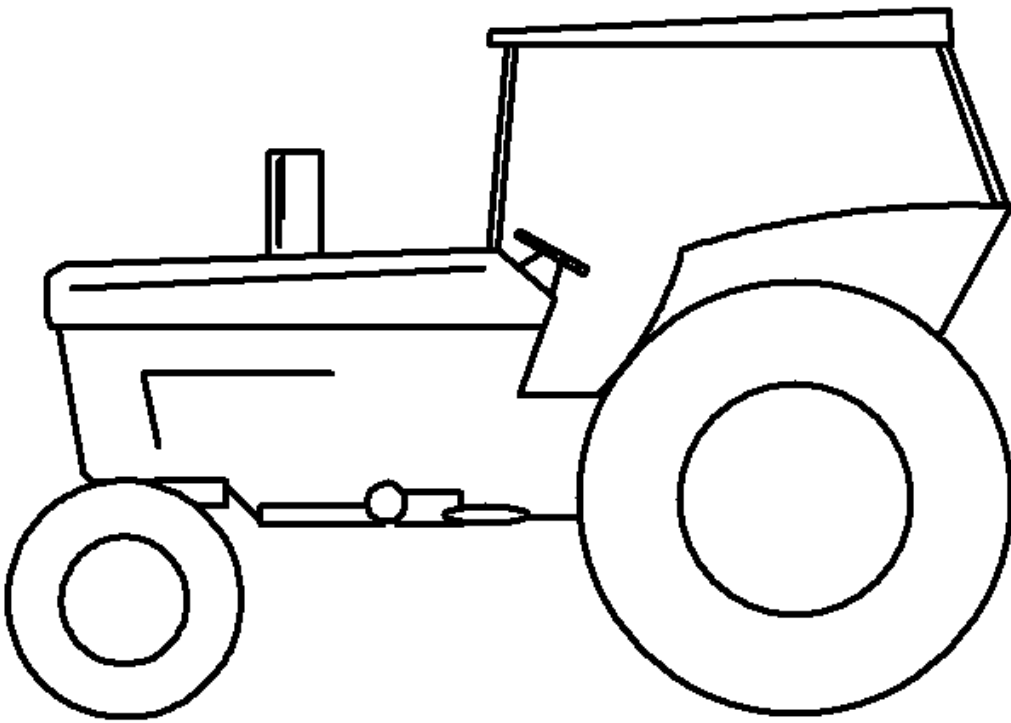
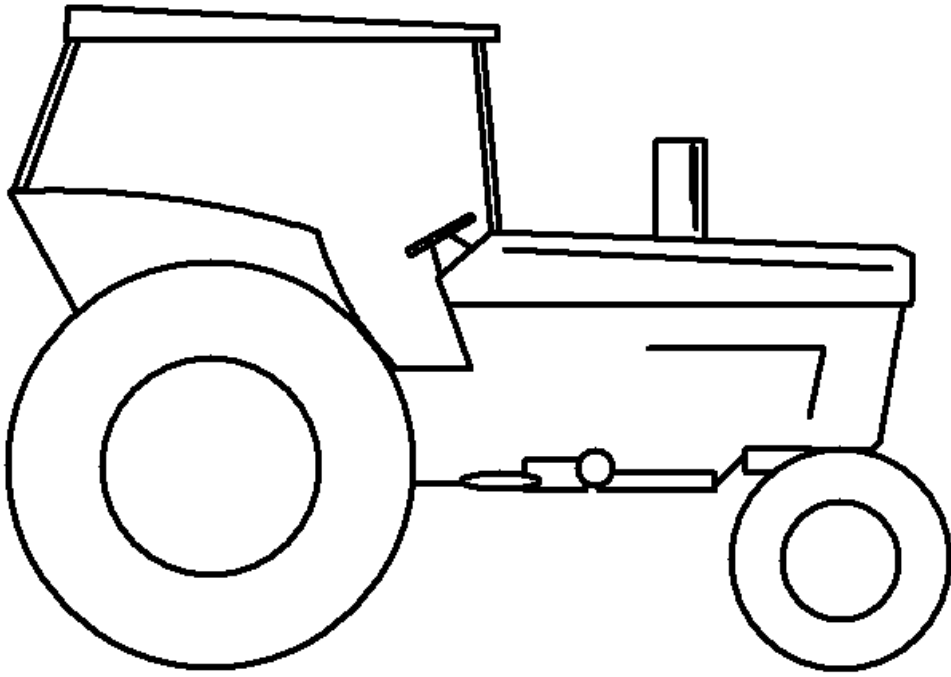

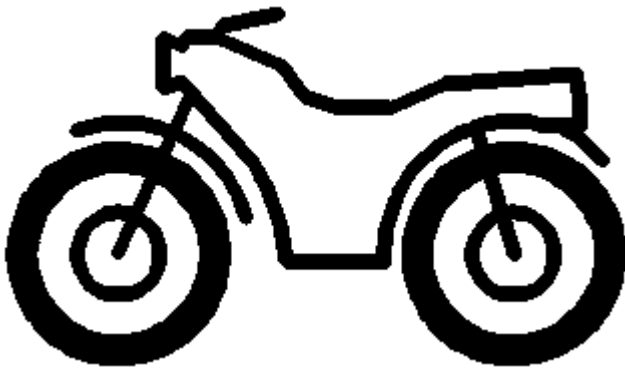
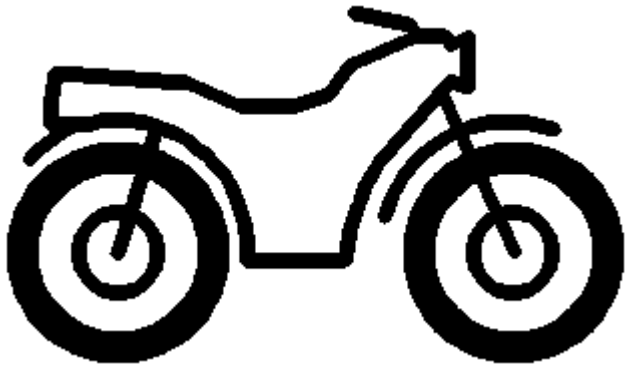
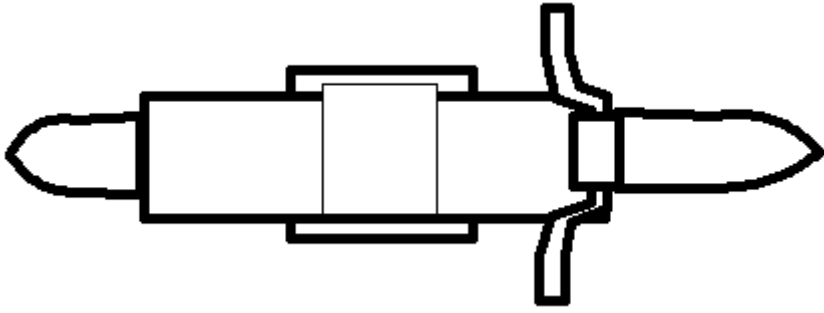

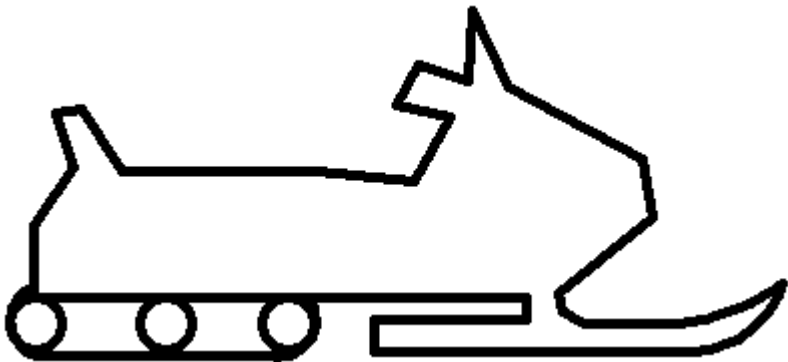
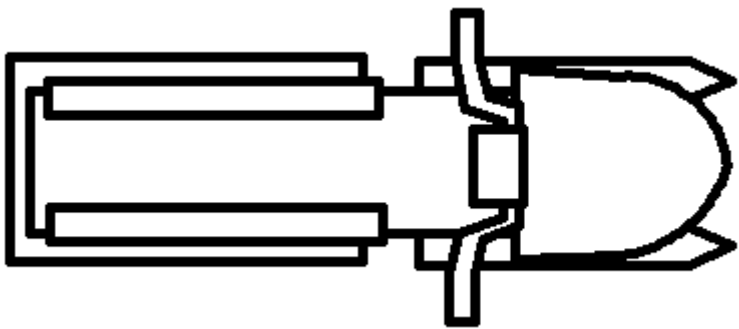

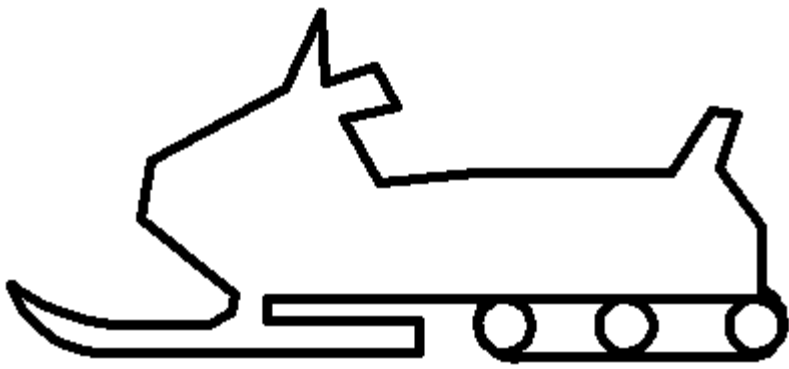

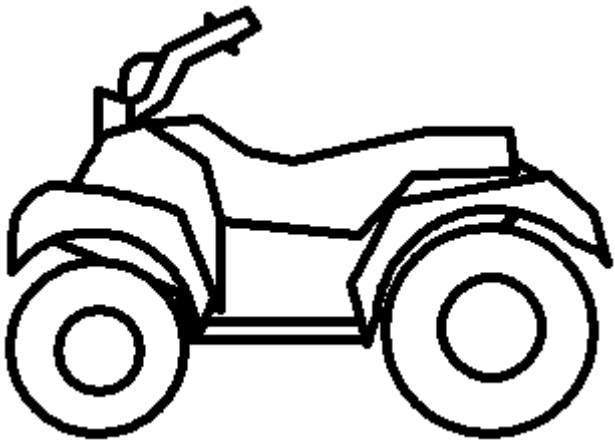
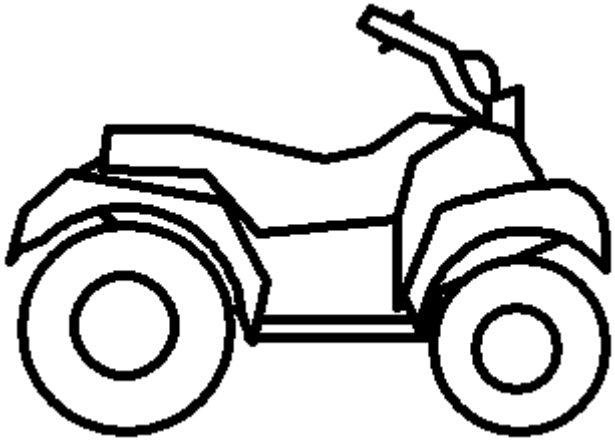
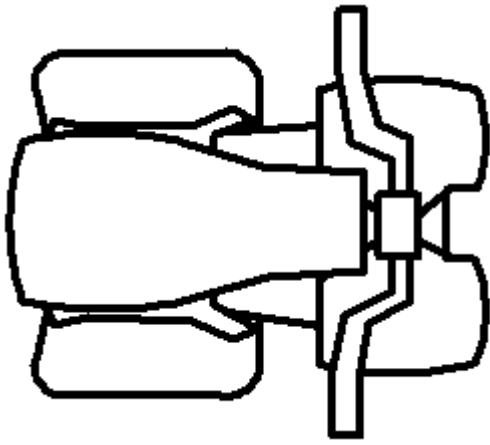

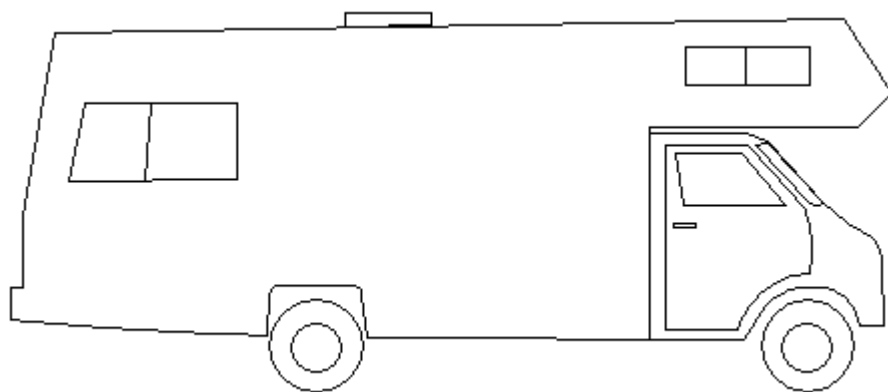
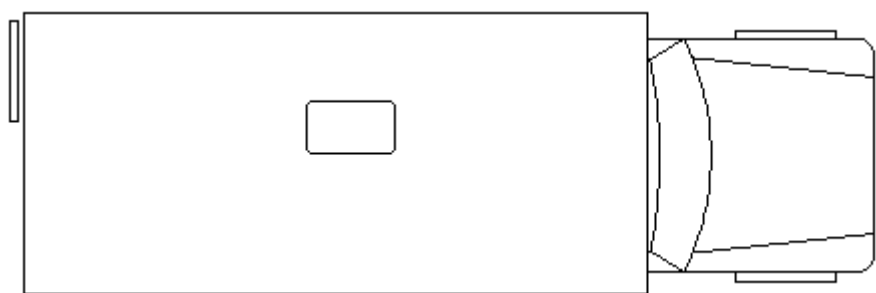

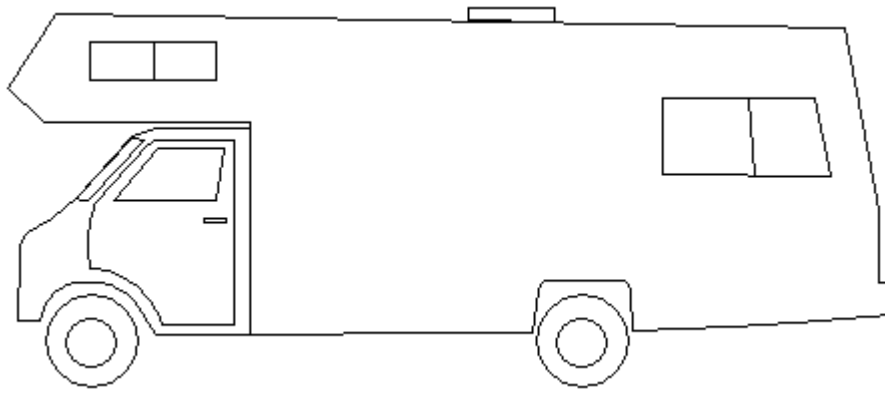

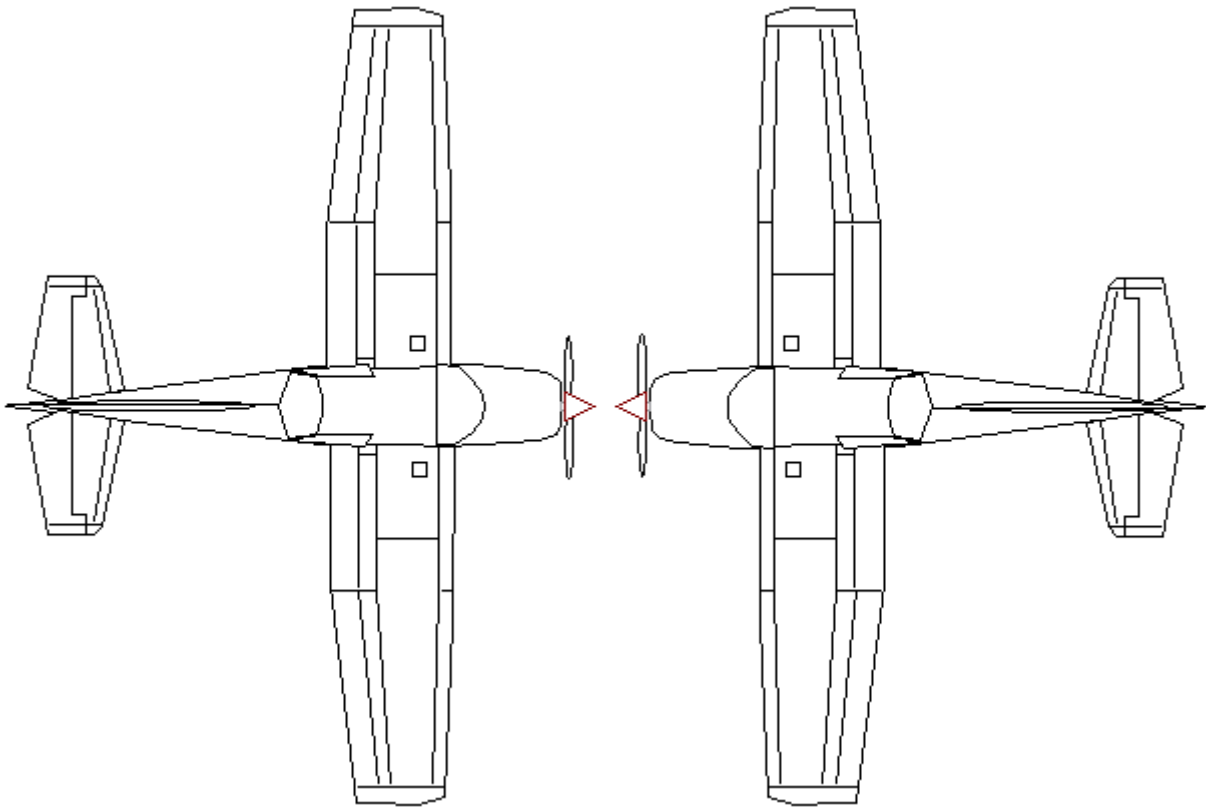
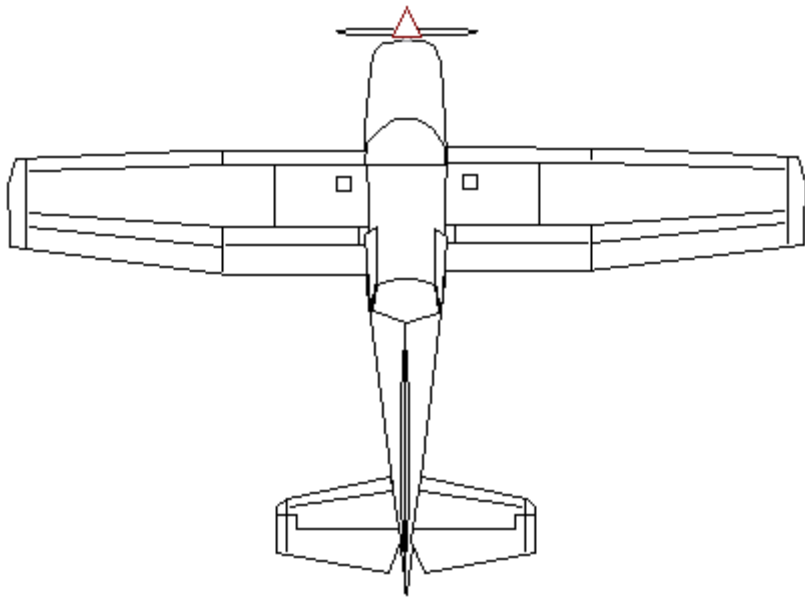

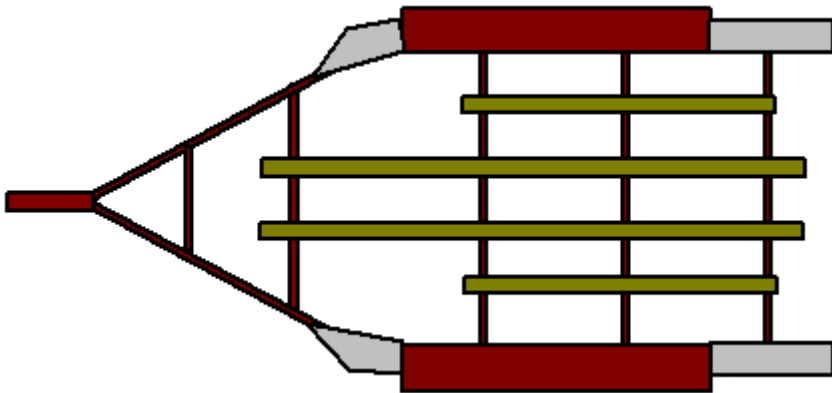
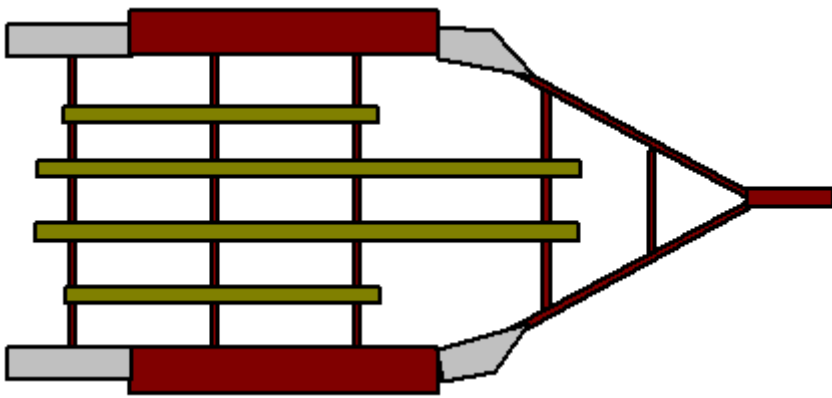
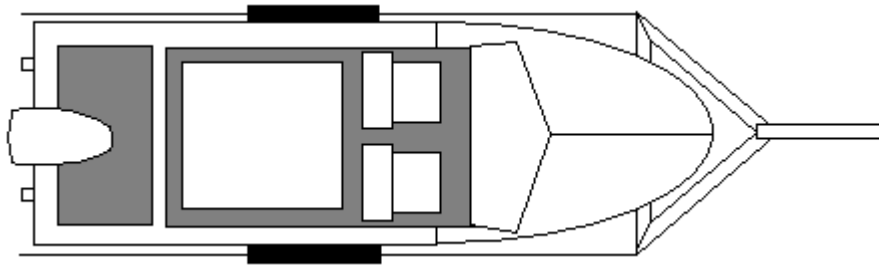
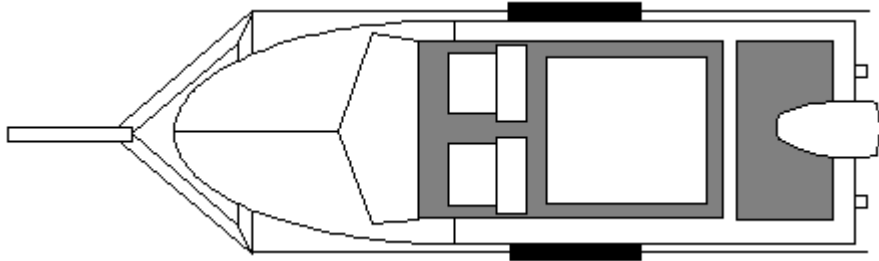

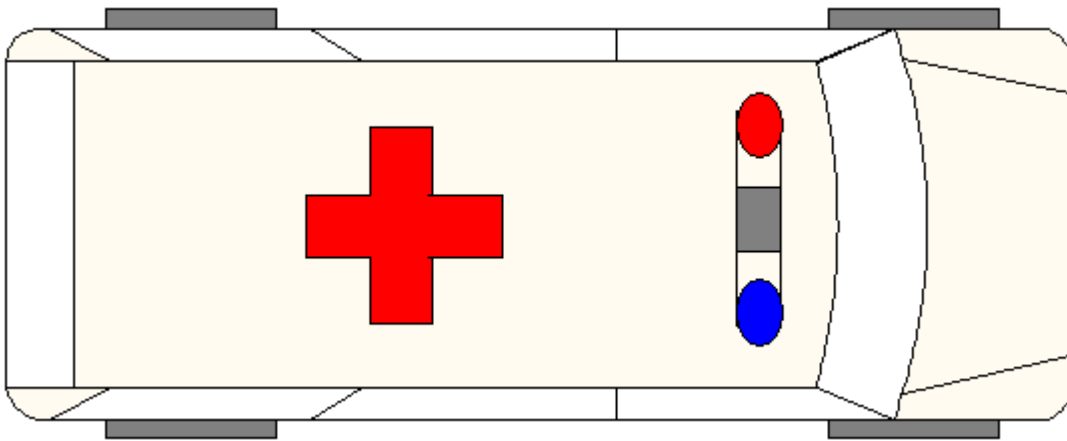
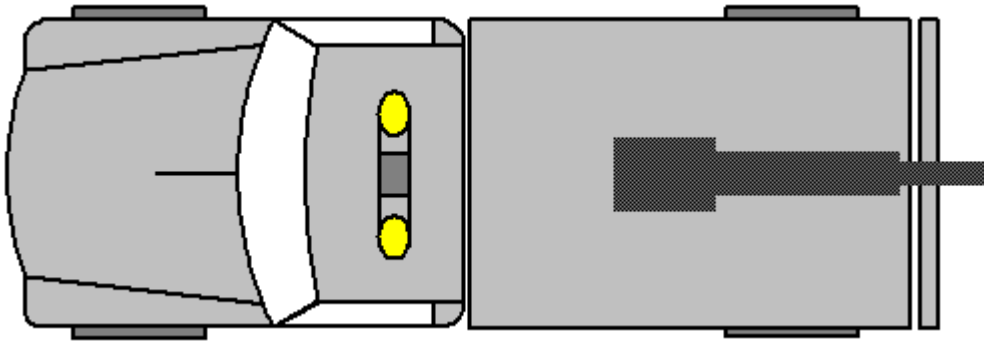
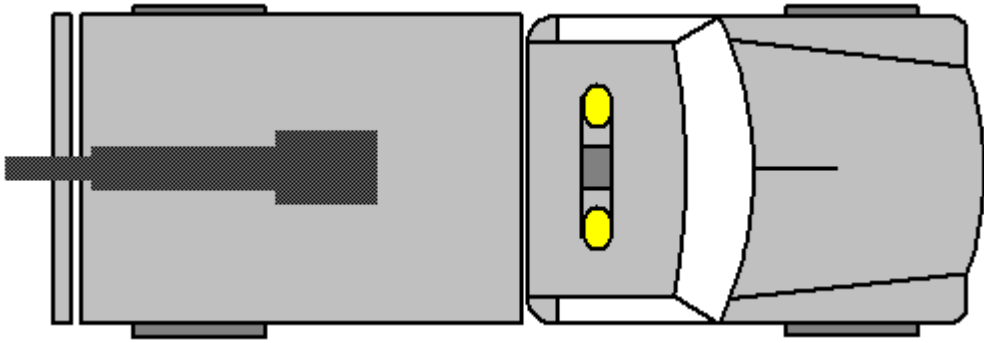

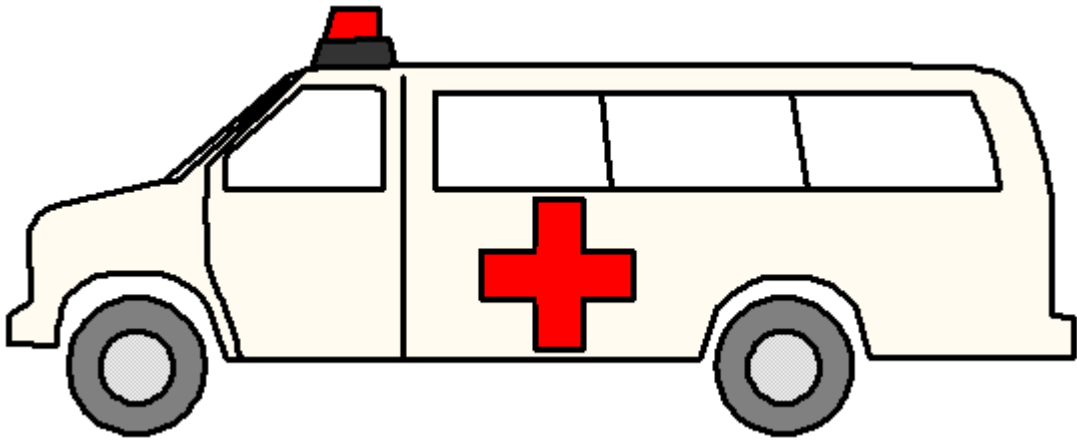
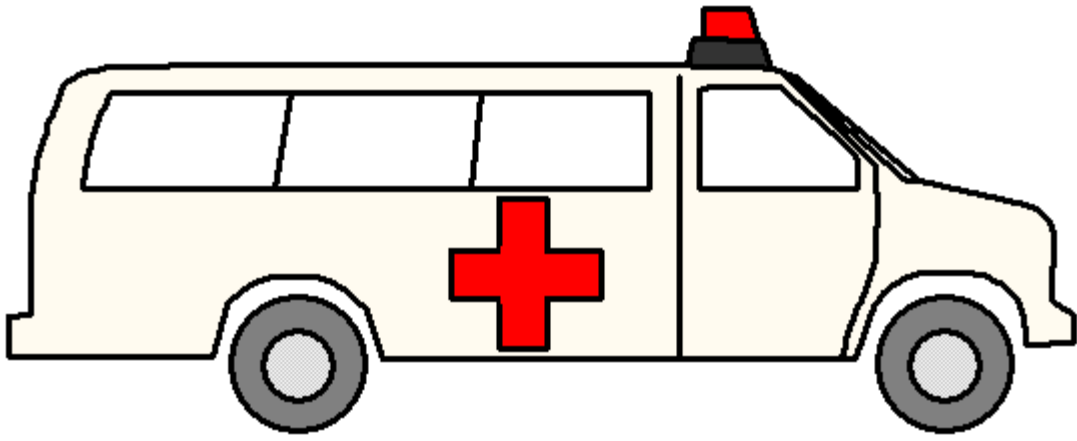

Case or File # _____ Date: _____ Time: _____
Vehicle Year: _____ Make: _____ Model: _____
Tag Number: _____ Expiration Date: _____
State: _____ VIN: _____
Investigator: _____

Pickup

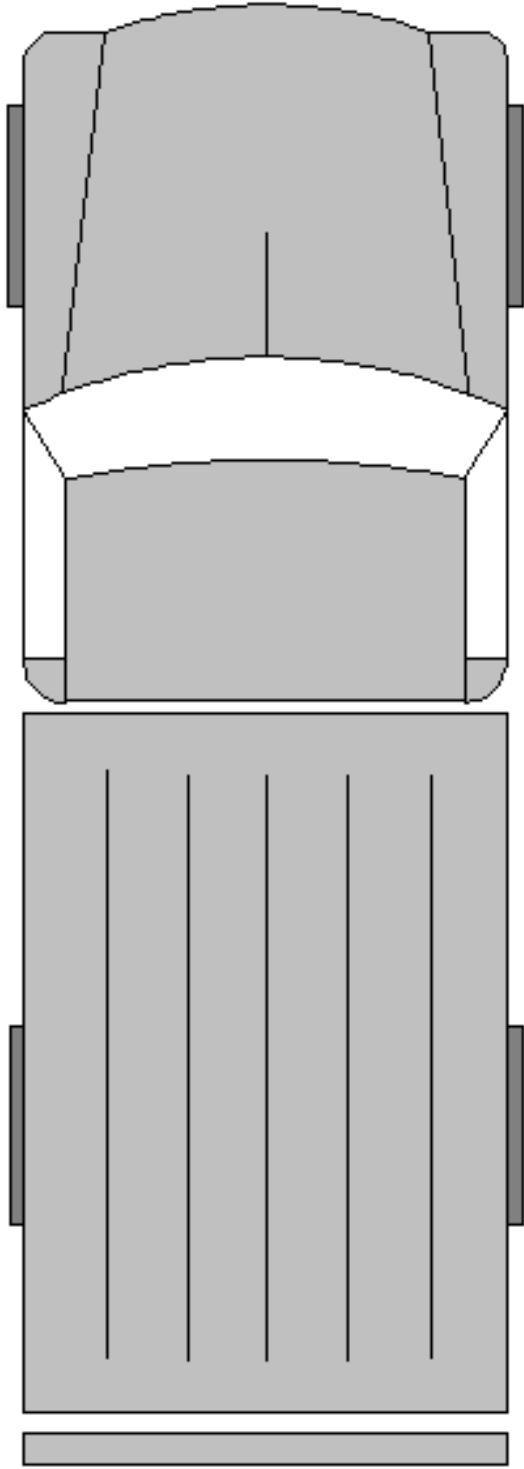

PICKUP SIDE VIEWS

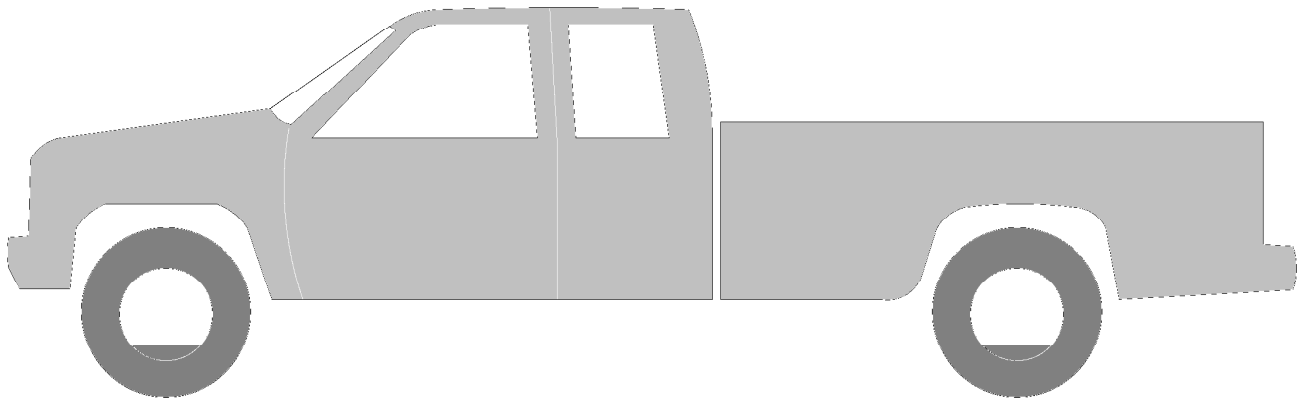
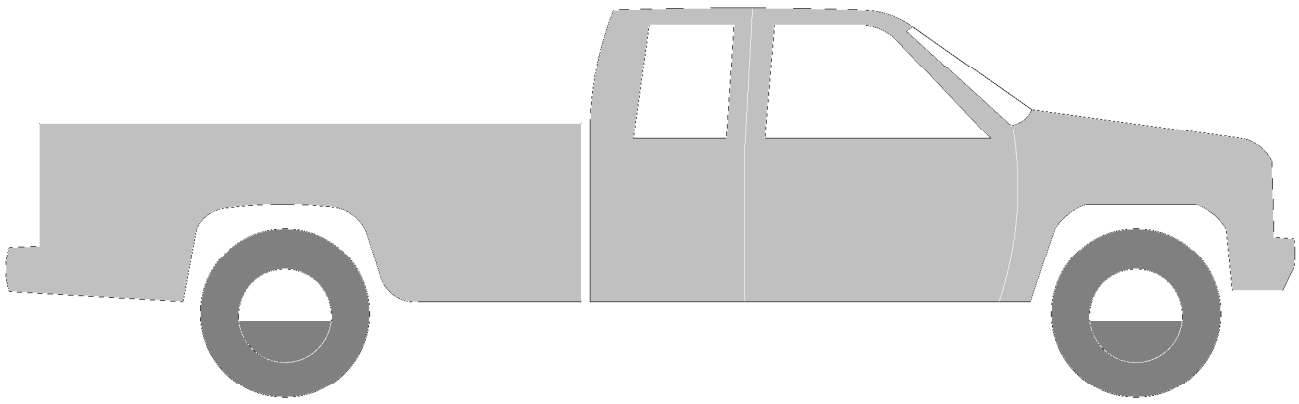

PHOTOGRAPHY LOG

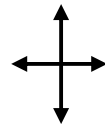

GPS _____ _____

Case or File # _____ [] Digital [] 35MM

Photographer: _____

- 1 ID _____
- 2 _____
- 3 _____
- 4 _____
- 5 _____
- 6 _____
- 7 _____
- 8 _____
- 9 _____
- 10 _____
- 11 _____
- 12 _____
- 13 _____
- 14 _____
- 15 _____
- 16 _____
- 17 _____
- 18 _____
- 19 _____
- 20 _____
- 21 _____
- 22 _____
- 23 _____
- 24 _____
- 25 _____

- 26 _____
- 27 _____
- 28 _____
- 29 _____
- 30 _____
- 31 _____
- 32 _____
- 33 _____
- 34 _____
- 35 _____
- 36 _____
- 37 _____
- 38 _____
- 39 _____
- 40 _____
- 41 _____
- 42 _____
- 43 _____
- 44 _____
- 45 _____
- 46 _____
- 47 _____
- 48 _____
- 49 _____
- 50 _____
- 51 _____
- 52 _____
- 53 _____

54	
55	
56	
57	
58	
59	
60	
61	
62	
63	
64	
65	
66	
67	
68	
69	
70	
71	
72	
73	
74	
75	
76	
77	
78	
79	
80	
81	

82	_____
83	_____
84	_____
85	_____
86	_____
87	_____
88	_____
89	_____
90	_____
91	_____
92	_____
93	_____
94	_____
95	_____
96	_____
97	_____
98	_____
99	_____
100	_____
101	_____
102	_____
103	_____
104	_____
105	_____
106	_____
107	_____
108	_____
109	_____

DIGITAL IMAGING CERTIFICATION

Date: _____ Time: _____ Case or file# _____

Digital camera: Brand _____ Model: _____

Capture resolution _____ [] various settings

Total number of images captured: _____

I/we hereby certify that the above described images captured associated with this case have been reviewed, printed, secured and CD/DVD protected by _____.

I/we further certify that no unauthorized alterations, manipulations or misrepresentations have been performed to any image captured.

Only approved enhancements from the permanent archive are allowed as prescribed by policy and procedure to provide a better viewing ability.

Any such enhancements shall be listed as such.

All images are a true and accurate representation of the images captured at the time they were captured.

NFPA® 921-2011 edition chapter 15.2.3.4 digital photography

NFPA® 921-2011 edition chapter 15.2.3.4.1 enhancement

NFPA® 921-2011 edition chapter 15.2.3.4.2 preserve, methodology to allow authentication.

Investigator

date

time

EVIDENCE [] PROPERTY [] LOG

CASE# _____ ITEM# _____ DATE _____ TIME _____

OFFICER/INVESTIGATOR _____

SUSPECT: LAST _____ FIRST _____ MIDDLE _____

VICTIM: LAST _____ FIRST _____ MIDDLE _____

ADDRESS: _____ CITY _____ STATE _____

(PROPERTY CODE _____) DESCRIPTION _____
ZIP _____

STORED: _____ RECEIVING OFFICER: _____

CHAIN OF CUSTODY

FROM _____ TO _____ DATE _____ TIME _____

FROM _____ TO _____ DATE _____ TIME _____

FROM _____ TO _____ DATE _____ TIME _____

FROM _____ TO _____ DATE _____ TIME _____

FROM _____ TO _____ DATE _____ TIME _____

FROM _____ TO _____ DATE _____ TIME _____

FROM _____ TO _____ DATE _____ TIME _____

FROM _____ TO _____ DATE _____ TIME _____

FROM _____ TO _____ DATE _____ TIME _____

FROM _____ TO _____ DATE _____ TIME _____

DISPOSITION

[] OWNER/FINDER [] DESTROYED [] CONVERT TO AGENCY [] AUCTION [] OTHER

RELEASED TO _____ ADDRESS _____

SIGNATURE _____ DATE/TIME: _____

RELEASED BY: _____